



UPS

1-10KVA

ONLINE TOWER UPS

USER MANUAL

Uninterruptible Power Supply

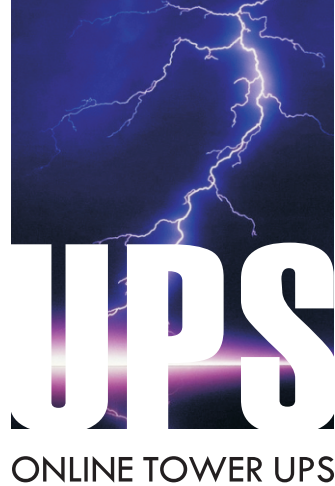

Thanks for using our products.
Please strictly obey all the instructions in this manual and pay attention to all the warning and operation information. It is not advisable to install or operate the machine before reading this manual.

Table of contents

| | |
|---|----|
| 1. Safety instructions | 01 |
| 1.1 UPS safety instructions | 01 |
| 1.2 Battery safety instructions | 01 |
| 2. Features | 02 |
| 2.1 Unpacking inspection | 02 |
| 2.2 UPS rear panel view | 02 |
| 3. Installation instructions | 04 |
| 3.1 Attention items of installation | 04 |
| 3.2 1-10K general UPS installation and output connection | 05 |
| 3.3 6-10K UPS with isolation transformer installation and output connection | 05 |
| 3.4 Parallel system of 6-10K UPS installation | 08 |
| 3.5 External battery connection procedure for long back up type | 12 |
| 3.6 Network functions | 13 |
| 4. Panel function and operation | 15 |
| 4.1 Keys function | 15 |
| 4.2 LED Function | 16 |
| 4.3 LCD display function | 16 |
| 4.4 Single UPS turn On/Off operation | 17 |
| 4.5 Single UPS self-test/mute operation | 18 |
| 4.6 Single UPS panel function setting | 18 |
| 4.7 Parameters inquiring operation | 22 |
| 5. Working mode introduction | 24 |
| 5.1 Bypass mode | 24 |
| 5.2 Line mode | 24 |
| 5.3 Battery mode | 24 |
| 5.4 ECO mode | 24 |
| 5.5 Fault mode | 25 |
| 6. The warning code list of the LED light and display panel | 25 |
| Appendix 1: The table of the fault code | 25 |
| Appendix 2: Table for working status | 26 |
| 7. Trouble shooting | 27 |
| Explicit Troubleshoot Introduction Sheet | 27 |
| Appendix 1: EMC Level | 29 |
| Appendix 2: Symbol instructions | 29 |
| Appendix 3: Specification Sheet (1-3KVA) | 30 |
| Appendix 4: Specification Sheet (6-10KVA) | 31 |
| Appendix 5: Physical (The type of 220V) | 32 |
| Appendix 6: Physical (The type of 120V) | 32 |

1 Safety instructions

1.1 UPS safety instructions

- Before applying the UPS system, Please read through all safety information and operating instructions carefully. It's recommended to save this manual properly for future reading.
- Do not install the UPS system near the water or in moist environments.
- Do not install the UPS system where it would be exposed to direct sunlight or near the heater.
- Place the UPS staying away from the wall for some distances, ensure enough space on each side of UPS, do not block ventilation holes in the UPS housing. Install it by following the instructions in the manual.
- Please do not open the UPS case as you will, there is a high risk of electric shocks inside.
- Do not connect to the equipment like hair dryer or electric heater, to ensure the safety for the UPS.
- Do not use liquid extinguisher if there is a fire, a dry powder extinguisher is recommended.

Attention:
 UPS has high voltage inside, for personal safety, please do not repair by yourself. If any questions, please contact local service center or dealer.

1.2 Battery safety instructions

- Battery life cycle will be shortened as environment temperature rise. Replacing battery periodically can help to keep UPS in normal state and assure backup time required.
- Battery replacement should be done by authorized technician. If you want to replace the battery cable, please purchase it from our local service center or distributors to avoid fever and lighter which can cause fire from inadequate power capacity.
- Batteries may cause electric shocks and have a high short-circuit current, for human being safety, please follow the specifications as below when replace the batteries:
 - A. Remove wristwatches, rings and other metal objects;
 - B. Use only tools with insulated grips and handles;
 - C. Wear insulated shoes and gloves;
 - D. Do not put the metal tools or parts on the battery;
 - E. Before disconnecting the terminals on battery, please cut off all the loads to battery first.
- Do not dispose of the batteries with fire so as to avoid explosion.
- Don't open the battery, electrolyte inside will do harm to eyes and skin. Please use plenty of clean water to wash if touching and go to see a doctor.
- Do not connect the positive pole and negative pole directly, otherwise it cause electric shocks or will be on fire.
- The battery circuit is not isolated from the input voltage, high voltage may occur between the battery terminals and ground, before touching, please verify no voltage is present.

2 Features

2.1 Unpacking inspection

- Open the UPS package, please check the enclosed accessories including a user manual, communication cable, CD-ROM. The long-back model also includes the cable for connection to battery bank.
- Check the UPS if any damage in transport. If find damaged or parts missing, do not power on, please turn to the carrier and dealer.
- To determine whether this UPS is the model you want to buy. Check the model name showed both on the front panel and rear panel of UPS to confirm.

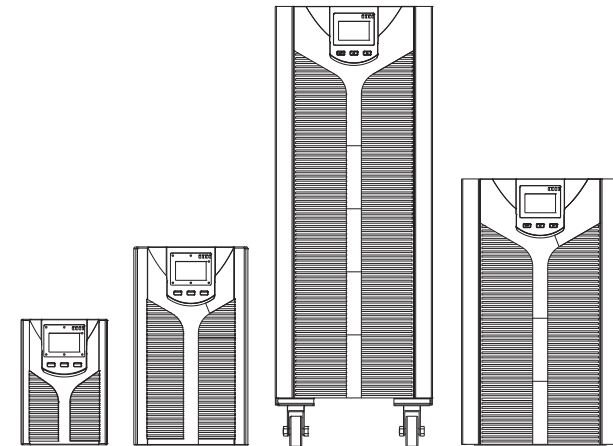

| Model | Type | Model | Type |
|----------|------------------------|----------|---------------------------|
| 1KVAS | 1KVA Standard model | 1KVAH | 1KVA Long backup model |
| 1.5 KVAS | 1.5 KVA Standard model | 1.5 KVAH | 1.5 KVA Long backup model |
| 2KVAS | 2KVA Standard model | 2KVAH | 2KVA Long backup model |
| 3KVAS | 3KVA Standard model | 3KVAH | 3KVA Long backup model |
| 6KVAS | 6KVA Standard model | 6KVAH | 6KVA Long backup model |
| 10KVAS | 10KVA Standard model | 10KVAH | 10KVA Long backup model |

Note:
Please save the packaging box and packaging materials for future transport use. As heavy product, please transit the UPS with care.

2.2 UPS rear panel view

2.2.1 The type of 220V (output could be 208V, 220V, 230V, 240V)

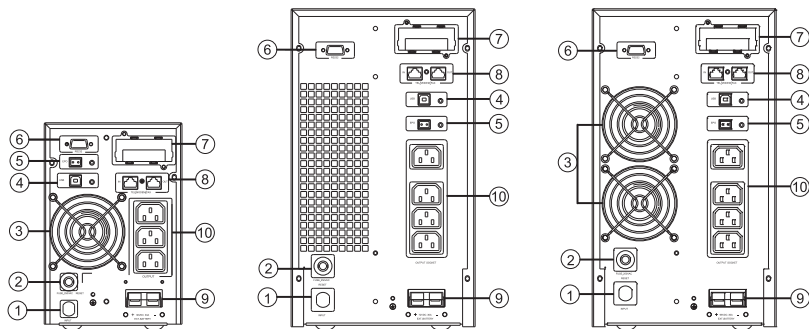

a. 0.9PF 1KVA rear panel

b. 0.9PF 1.5KVA&2KVA rear panel

c. 0.9PF 3KVA rear panel

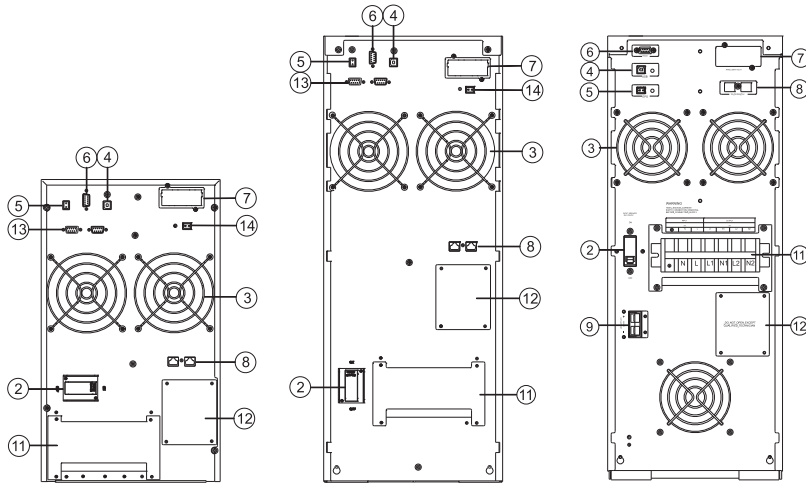

d. 6KVA & 10KVA Long back up

e. 6KVA & 10KVA Standard type

f. 6KVA & 10KVA with ISO

2.2.2 The type of 120V (output could be 100V, 110V, 115V, 120V, 127V)

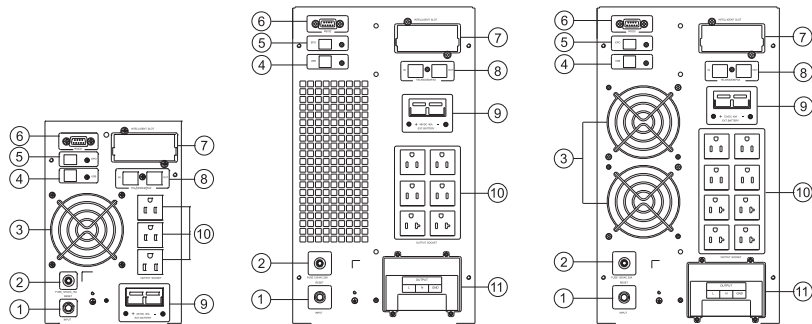

a. 0.9PF 1KVA rear panel

b. 0.9PF 2KVA rear panel

c. 0.9PF 3KVA rear panel

| | |
|----------------------------------|---|
| 1 Input Power Terminals; | 8 Surge Protection for Network/Fax/Modem; |
| 2 Over Current Protector; | 9 Battery Slot; |
| 3 Fan; | 10 Output Socket; |
| 4 USB; | 11 Terminal Block; |
| 5 Emergency Power Off; | 12 Manual Bypass Switch Cover; |
| 6 RS232 Communication Interface; | 13 Parallel Port; |
| 7 Intelligent Slot; | 14 Reserved Port. |

Note:

Diagrams take the type of 0.9PF for example, the type of 0.8PF is similar. Due to the technology upgrading and development, goods and diagrams might have some differences.

3 Installation instructions

3.1 Attention items of installation

- The UPS installation environment must be with good ventilation, away from water, flammable gases and corrosive entities.
- Do not lie down the UPS against the wall so that front and side panel air intake hole, rear panel air outtake hole will be unobstructed.
- The peripheral environment temperature around the UPS should be within 0°C~40°C.
- If dismantling the machine at low temperatures, there may be condensation droplets, users can not install or operate it before UPS completely got dry both inside and outside, otherwise there will be danger of electric shock.
- Place the UPS near the mains socket to cut off AC mains without any delay at any emergent case.
- Make sure the load connect to the UPS is off when users connect the load to UPS, and then turn on the load one by one later.
- Please connect the UPS with the socket which is over-current protected. Do not connect the UPS with the socket which rated current is less than the Maximum input current of the UPS.
- All the power socket should be configured with earthing device for safety.
- UPS could be electrified or powered no matter the input power cable is tied or not, even when the UPS is off. The only way to cut off the output is switching off the UPS and disconnecting the mains power supply.
- For all standard type UPS, it is advised to charge the battery over 8 hours before used. Once the AC mains power energizes the UPS, it will automatically charge the battery. Without prior charging, UPS output remains as usual but with shorter back-up time than normal.
- When connected to motor, display equipment, laser printer etc, UPS power selection should be based on the startup power of the load which is usually twice as rated power.

- When wiring, please ensure input cables and output cables are connected firmly.
- If install a leakage current protective switch, please install it on output cable.
- For EA900II 6-10K Series UPS, before installing, prepare wires for terminal block of the UPS based on the following table.

| Model | Wiring spec(AWG) | | | | |
|---------|-------------------|-------------------|-------------------|----------------------|-------------------|
| | Input | Output | Battery | Non-isolated Neutral | Ground |
| 6KVA S | 6mm ² | 6mm ² | 6mm ² | 6mm ² | 6mm ² |
| 6KVA H | 6mm ² | 6mm ² | 6mm ² | 6mm ² | 6mm ² |
| 10KVA S | 10mm ² | 10mm ² | 10mm ² | 10mm ² | 10mm ² |
| 10KVA H | 10mm ² | 10mm ² | 10mm ² | 10mm ² | 10mm ² |

3.2 1-10K general UPS installation and output connection

Normally, output connection of 1~10KVA type is configured with sockets or terminal blocks, users can plug the load cable into the UPS socket to energize the load as following pictures. Make sure the mains wire and breakers in the building are enough for the rated capacity of UPS to avoid the hazards of electric shock or fire.

Note:

For the type of 6-10KVA, do not use the wall receptacle as the input power source for the UPS, which rated current is less than the UPS's maximum input current. Otherwise the receptacle may be burned and destroyed.

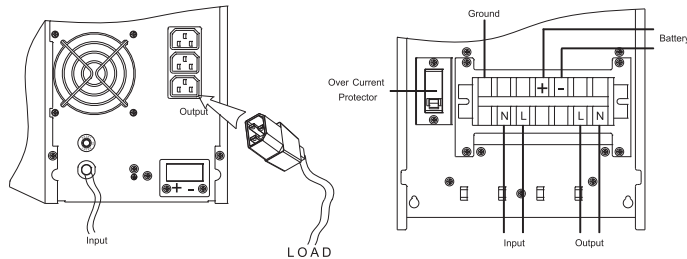

3.3 6-10K UPS with isolation transformer installation and output connection

For the type of 6~10KVA which contains isolation transformer, output connection of 6~10KVA type is only configured with terminal blocks, there are more methods to output different voltage, more different output connections. Before installing, prepare wires for terminal block of the UPS based on the wiring spec table above in attention items.

Note:

- ① The cable for 6KVAS/6KVAS should withstand over 40A current. It is recommended to use 10AWG or thicker wire for safety and efficiency.
- ② The cable for 10KVAS/10KVAS should withstand over 63A current. It is recommended to use 8AWG or thicker wire for safety and efficiency.

- ③ The selections for color of wires should be followed by the local electrical laws and regulations.

Installation:

A. Remove the terminal block cover on the rear panel of UPS. Then connect the wires according to the following terminal block diagrams: Connect the earthing wire first when making wire connection. Disconnect the earthing wire last when making wire disconnection!

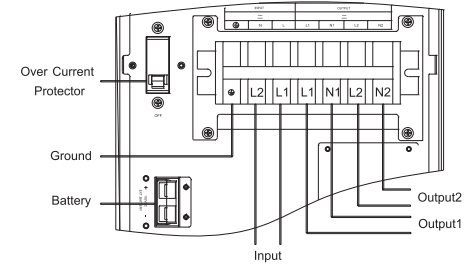

Note:

- ① Make sure the wires are connected tightly with the terminals.
- ② There are two output terminals to meet customers' diverse requirements for serial or parallel connection. We will introduce the methods of connection later.
- ③ Please install the output breaker between the output terminal and the load, and the breaker should be qualified with leakage current protective function if necessary.

B. Insert the EPO plug into the EPO slot on the rear panel.

C. Put the terminal block cover back to the rear panel of the UPS.

Caution: (only for long-run type UPS)

- Make sure a DC breaker or other protection device between UPS and external battery pack is installed. if not, Please install it carefully. Switch off the battery breaker before installation.
 - Note:** Set the battery pack breaker in "OFF" position and then install the battery pack.
- Pay highly attention to the rated battery voltage marked on the rear panel. if you want to change the numbers of the battery pack, please make sure you modify the setting simultaneously. The connection with wrong battery voltage may cause permanent damage of the UPS. Make sure the voltage of the battery pack is correct.
- Pay highly attention to the polarity marking on external battery terminal block, and make sure the correct battery polarity connected. Wrong connection may cause permanent damage of the UPS.
- Make sure the protective earth ground wiring is correct. The wire current spec, color, position, connection and conductance should be checked carefully.
- Make sure the utility input & output wiring is correct. The wire current spec, color, position, connection and conductance should be checked carefully. Make sure the L/N site is correct, not reverse or short-circuited.

Output Configuration

Option 1:

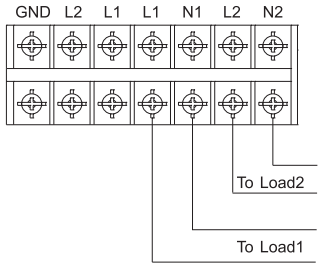

There are 2 sets of low-voltage output (100V/110V/115V/120V) with L1-N1 and L2-N2. Each of them is able to provide 50% of UPS rating power. Connect one load to L1-N1 and the other load to L2-N2.

Option 2:

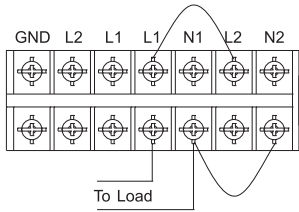

After connecting L1 & L2 and N1&N2, it becomes one low-voltage output (100V/110V/115V/120V) at L1-N1 for 100% of UPS rating power. Connect load to L1-N1 or L2-N2.

Option3:

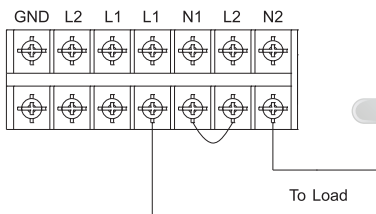

After connecting N1 & L2, it becomes one low-voltage output (208V/220V/230V/240V) at L1-N2 for 100% of UPS rating power. Connect load to L2-N1.

Option4:

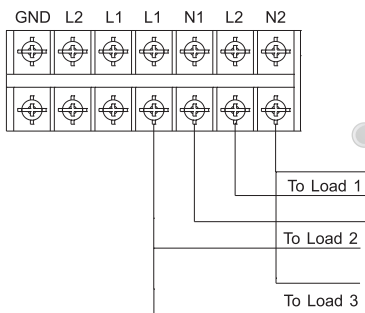

After connecting N1 & L2, it becomes three outputs, one high-voltage (208V/220V/230V/240V) at L1-N2 two low-voltage outputs (100V/110V/115V/120V) at L1-N1 and L2-N2. However, there is a limit for current rating at L1-N1 and L2-N2: 25A is for 6KVA model and 42A is for 10KVA model. You must connect the load under the limitation. Please read Note first before installation. Connect low-voltage load to L1-N1 and L2-N2, and connect high-voltage load to L1-N2.

Note:

- ① if any load current in L1-N1 or L2-N2 is higher than 25A in 6KVA model and 42A in 10KVA model. The UPS will still operate normally without overload warning because the total load is under the specification. However, the isolation transformer will be damaged with overheat due to high current. Hence, the installation must be done with technician and make sure that the load current does not exceed this limitation.
- ② When connecting to low-voltage and high-voltage at the same time like option 4, it will cause the L1-N1 & L2-N2 with low-voltage loads in Non-Isolated status, we recommend that you may only use two low-voltage at L1-N1 or L2-N2 like option 1, and also make sure that the total current in L1-N1 or L2-N2 does not exceed the value on Note 1.

3.4 Parallel system of 6-10K UPS installation

Only 6-10K UPS and containing parallel ports can do parallel operation, other types is not supported.

N+X parallel structure is the most reliable power supply structure at present, N stands for the minimum number of UPS for the load, X stands for the number of redundant UPS, X absolutely means how many UPS could be malfunctioning at the same time and the parallel UPS system is still steady. The larger X is, the system is more reliable. N+X is the best method for high reliability. Just install a little more simple accessories, at most 8 UPS could work together to form a flexible parallel system.

This structure of power supply system increases the power safety and reliability. For example, two single UPS make up a parallel system to load averagely, when one is malfunctioning, another one can take all the load independently. It allows isolation repairs for malfunctioning UPS, and according to users own different requirements, every single UPS could install manual maintenance bypass switch.

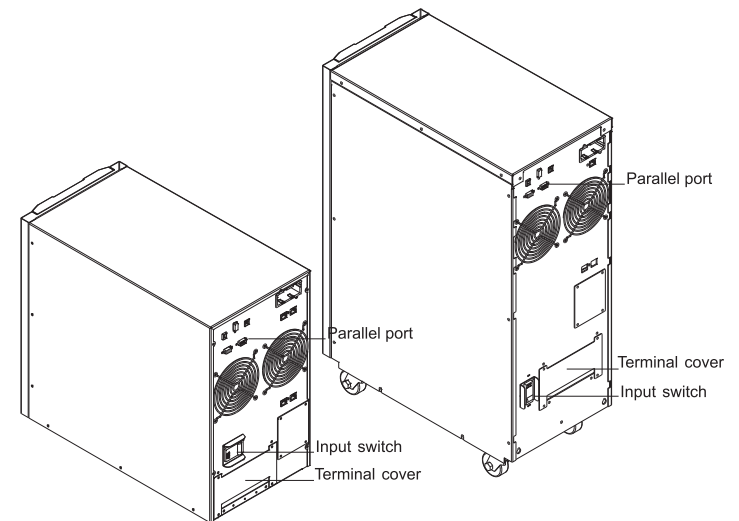

3.4.1 Parallel system installation

The function of parallel operation is an optional function of UPS, users can purchase parallel function parts (including parallel card and parallel wire) and contact service personnel to install. At most 8 UPS work together by using parallel wires to form a flexible parallel system. Each UPS should be equipped individual battery pack.

➤ Parallel system installation requirement:

- Install parallel wire, users need to purchase a specific parallel wire from our company, it's not recommended to use other type parallel wires. There are 2m length and 5m length to be chosen.
- Prepare wires for terminal block of the UPS based on the wiring spec table above in attention items.
- Each UPS input wiring please comply with the requirements of single UPS wiring.
- Every UPS is recommended to connect together to one common utility power terminal block.
- The output cables of each UPS are recommended to connect together on a common terminal block, then output to the load.
- Each UPS should be equipped individual battery pack.
- Wiring installation for parallel UPS system please refer to the wiring diagrams are given below, switches of 6KVA should withstand more than 40A/250VAC, and switches of 10KVA should withstand more than 63A/250VAC.
- Output wiring length requirements: when the distance between the load and each UPS is less than 20 meters, the length difference of cables to the load should be less than 20%; when the distance between the load and each UPS is more than 20 meters, the length difference of cables to the load should be less than 10%.

➤ Installation procedure:

- ① Install parallel wires. Two UPS to form an UPS parallel system, in order to ensure the reliability of the parallel system, there is only one way to wire two UPS, use two parallel wires to connect two UPS like the diagram showing below, connection looks like a circle. If three or more than three UPS are needed, the connection is similar, you can refer to the diagram as below. How many UPS unit, how many parallel wires you need.

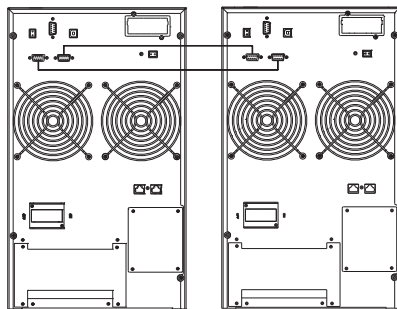

Parallel system of two UPS wiring

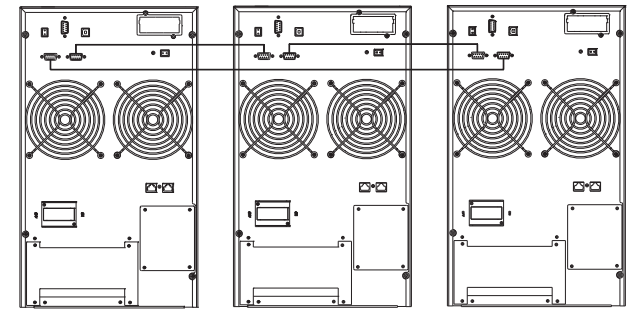

Parallel system of three UPS wiring

Attention:



For three UPS parallel system or more than three units system type, please remove the short pin CN3 on the parallel card as following pictures, Only keep the first unit and the last unit short pin(CN3) connected and remove the rest ones. Open the UPS cover, find the parallel card, it's installed on the rear panel. Take off the short pin CN3, then screw the cover back. It's advisable to contact to local dealer to operate, if you have to operate by yourself, please be sure that you have cut off all the electrical connection, be careful the electric shocks from the UPS inside.

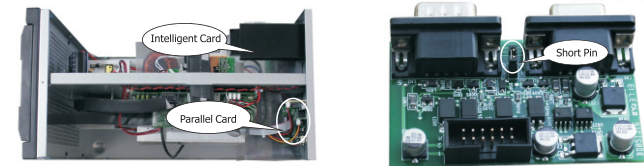

- ② Connect output cables of all UPS together to a common terminal block.
- ③ Connect input cables of all UPS together to one common utility power terminal block.

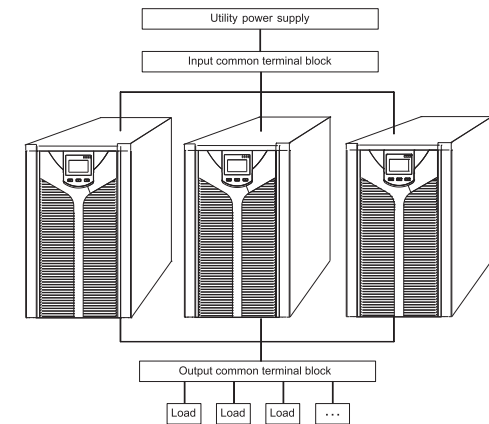

Parallel UPS system view

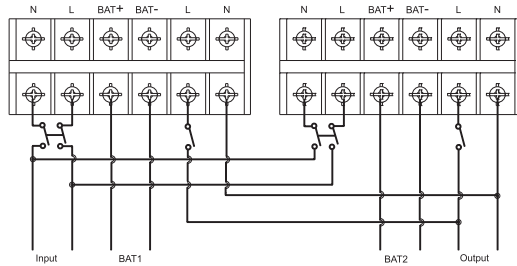

Wiring diagram for two UPS parallel system

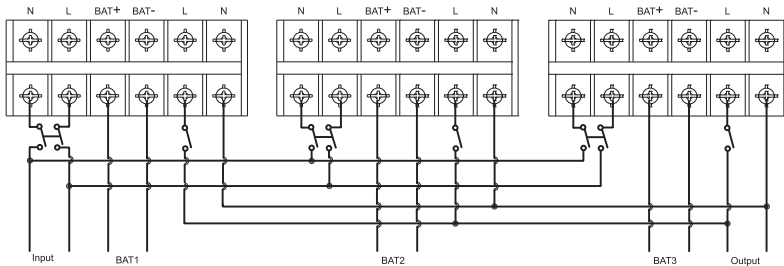

Wiring diagram for three UPS parallel system

- ④ If the UPS is the standard type, each UPS has batteries inside already. If the UPS is the long-run type, each UPS should be equipped a individual battery pack.
- ⑤ After installation, check all the wiring carefully, be sure to confirm correct, then can operate the system.

3.4.2 Parallel system operation and maintenance

General operation of parallel system, please refer to the operation instruction of single UPS. Before starting the system, need to set up different ID for each UPS, specific settings please refer to the instruction of ID setting which is given in single UPS panel function setting.

➤ Turn on the parallel system

- Start the system with mains power: After inputting the mains power, turn on any one UPS of system, others will start by themselves at same time. All UPS will enter into Line mode.
- Start the system without mains power: Make sure the battery pack is connected well and the breaker is in "ON" position. There are two ways to start the UPS parallel system without utility power supply:

A: Press the key  on each UPS, make each LCD of each UPS light up, then turn on any one UPS of system, others will start by themselves at same time. All UPS will enter into BAT mode.

B: Turn on UPS one by one.

➤ Turn off the parallel system

Hold on the OFF KEY of any one UPS of system for more than 4 seconds, it would turn off the whole parallel system. Hold on the OFF KEY of any one UPS of system for more than 1 second (less than 4 seconds), it would turn off single UPS you choose, of course if you need to turn on it again or turn on any other single UPS of the system, just press ON KEY of that UPS to start it.

➤ Parallel system maintenance

- Parallel system maintenance please follow the maintenance of single UPS.
- If one UPS of parallel system is malfunctioning, first of all, turn off the malfunctioning UPS, then cut off the input power to the faulty UPS and disconnect the output of faulty UPS to the parallel system, make sure that there is no electrical connection with malfunctioning UPS, after all of those, it's safe to do operation.

3.5 External battery connection procedure for long back up type

- For different UPS type, users are instructed to configure different battery voltage as below sheet. More or less units are forbidden, or else something abnormal or faulty will appear.

| Type | Battery Quantity(unit) | Battery Voltage(volt) |
|--------|------------------------|-----------------------|
| 1KVA | 2/3 | 24/36 |
| 1.5KVA | 4 | 48 |
| 2KVA | 4/6 | 48/72 |
| 3KVA | 6/8 | 72/96 |
| 6KVA | 16 | 192 |
| 10KVA | 16 | 192 |

- One end of battery cable is for UPS terminals while the other end with triple cables is for battery terminals. Correct installation procedure is highly vital or else probable electric shock will arise. Users are strictly required to follow the below procedure.
- Connect battery in correct way and make sure the total battery voltage is available for UPS.
- Correctly connect the long battery cable to battery terminals first, red wire is to positive plate while black is to negative. If users connect the UPS first, electric shock or other danger could not be avoided.
- Before connecting load after UPS, users should supply main power to UPS and energize it.
- Connect long battery cable to UPS terminals with correct poles link (red is for "+", black is for "-"), UPS will start the charging work automatically.
- For the type of 1-3K UPS, please connect the battery pack to the battery slot; For the type of 6-10k UPS, please connect the battery pack to the terminal block. Make sure all cables are connected firmly.

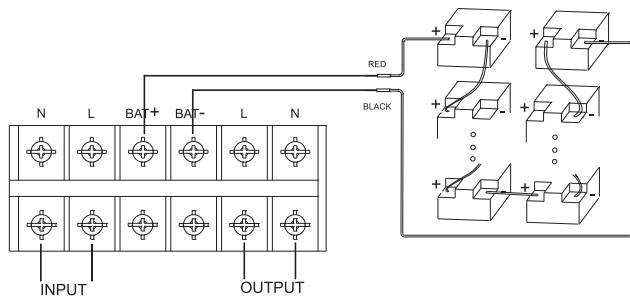

3.6 Network functions

3.6.1 Communication port

Users could monitor the UPS system through the communication port such as standard RS232 port and standard USB port with computer. With a communication wire to connect UPS and computer, could simply achieve UPS management.

➤ RS232 port:

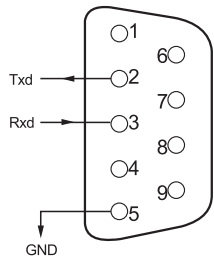

| Foot | Explanation | Foot | Explanation |
|------|-------------|------|-------------|
| 1 | empty | 6 | empty |
| 2 | send | 7 | empty |
| 3 | receive | 8 | empty |
| 4 | empty | 9 | empty |
| 5 | ground | | |

➤ USB port:

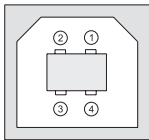

| Foot | Explanation | Foot | Explanation |
|------|-------------|------|-------------|
| 1 | +5V | 3 | date- |
| 2 | date+ | 4 | GND |

3.6.2 Intelligent card (option)

This series High frequency online UPS supply a intelligent slot on rear panel, it's for SNMP card, dry contact and USB card, users could insert any type intelligent card from those three into it to monitor and manager the UPS. You don't have to turn off the UPS when you install the intelligent card. Procedure as following:

- First of all, remove the intelligent slot cover;
- Then insert the intelligent card(SNMP card, dry contact or USB card);
- Last, screw the intelligent card back.

➤ SNMP card (option)

SNMP card on UPS is compatible with the most software, hardware and network operating system, it is a network management of UPS, with this function, UPS can login on internet, which can supply information of UPS status and input power, and even possible to control UPS via net management system.

➤ Dry contact card (option)

Insert the dry contact card into the intelligent slot, it's another type function of intelligent monitoring.

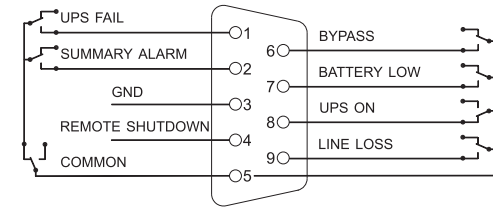

| Foot | Definition | Foot | Definition |
|------|---------------------------|------|--------------------|
| PIN1 | ON: UPS is malfunctioning | PIN6 | ON: Bypass mode |
| PIN2 | ON: Alarm(system failure) | PIN7 | ON: Battery low |
| PIN3 | Ground | PIN8 | ON: Inverter mode |
| PIN4 | Remote shutdown | | OFF: Bypass mode |
| PIN5 | Common | PIN9 | ON: No AC power in |

➤ USB card (option)

USB card is designed specially for high frequency online UPS series, the function is the same as the USB port.

3.6.3 EPO port (option)

EPO is short for Emergency Power Off, EPO port is on rear panel of UPS, it's green, in some emergent cases, users could cut off the output of UPS immediately by operating EPO port. Wiring diagram as below:

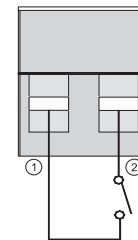

Normally, pin1 and pin2 are connected so that the machine can be working normally. When some emergencies happen, and when users do have to cut off the output, just need to disconnect the connection between pin1 and pin2, or there is a another useful simple way is pulling it out.

All above, for more information, please contact to the local dealer.

4 Panel function and operation

The operation is simple, operators only need to read the manual and follow the operation instructions listed in this manual without any special training.

4.1 Keys function

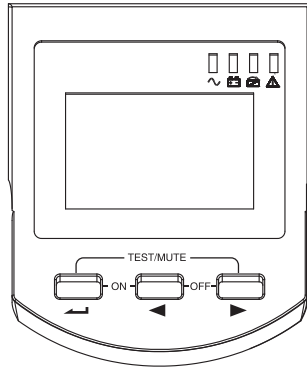

➤ ON KEY (← + ◀)

Press and hold the two keys for more than half a second to turn on the UPS.

➤ OFF KEY (◀ + ▶)

Press and hold the two keys for more than half a second to turn off the UPS.

➤ TEST/MUTE KEY(← + ▶)

Press and hold the two keys for more than 1 second in Line mode or ECO mode or CUCF mode: UPS runs the self-test function.
 Press and hold the two keys for more than 1 second in battery mode: UPS runs the mute function.

➤ INQUIRING KEY(◀ , ▶)

Non-function setting mode:
 Press and hold ◀ or ▶ for more than half a second (less than 2 seconds): display the items orderly.
 Press and hold ▶ for more than 2 seconds: Circularly and orderly display the items every 2 seconds, when press and hold the key for some time again, it will turn to output status.
 Function setting mode:
 Press and hold the key ◀ or ▶ for more than half a second (less than 2 seconds): Select the set option.

➤ FUNCTION SETTING KEY(←)

Non-function setting mode:
 Press and hold the key for more than 2 seconds: Function setting interface.

Function setting mode:
 Press and hold the key for more than half a second (less than 2 seconds): Enter the function setting option.
 Press and hold the key for more than 2 seconds: exit from this function setting interface.

4.2 LED Function

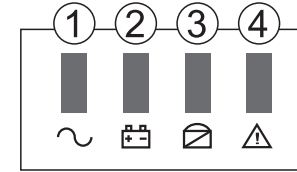

| Number | LED | Explanation |
|--------|--------------|---|
| ① | Inverter LED | Inverter green LED is on: UPS is normally powered by Line mode or ECO mode or BAT mode. |
| ② | Battery LED | Battery yellow LED is on: Battery mode. |
| ③ | Bypass LED | Bypass yellow LED is on: Bypass mode or ECO mode, etc. |
| ④ | Warning LED | Warning red LED is on: UPS fault. For example: Overload beyond the allowed time, inverter fault, BUS fault, over temperature fault, etc |

PS: LED display detail in different mode is listed at the back.

4.3 LCD display function

LCD displays as following figure.

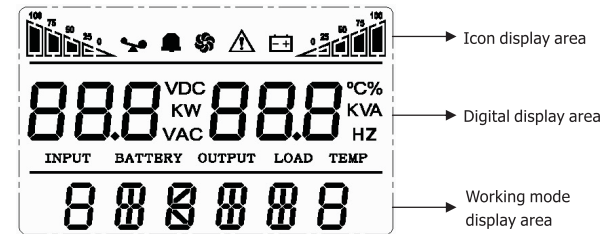

➤ Icon display area:

- A. The top diagram is for load and battery capacity indication, each grid of which represents 25%. When UPS is over load, the load light will blink the same as the battery light blink when the capacity of battery get low or battery disconnected.
- B. The fan icon is for fan working indication; when fan normally runs, the icon will display rotation; if the fan is not connected or faulty, the icon blinks;

- C. Press the mute button under the battery mode, buzzer icon will blink; it will disappear in other cases.
- D. Fault icon will be on when UPS is in fault mode, otherwise it will not.

➤ **Digital display area:**

- A. Under none setting mode, it will display UPS output information when UPS normally runs in AC mode; other information like input, battery, load and temperature will be showed after pressing the inquiring key; Fault code will be told in fault mode.
- B. Under setting mode, users could adjust different output voltage, activate ECO mode, activate CUCF mode, select an ID number and so on by operating function setting key and inquiring keys.

➤ **Mode display area:**

- A. This area will display the power capacity of the machine after starting the UPS within 20 seconds.
- B. After over 20 seconds, this area will display the working mode of the machine. Such as STDBY(standby Mode), BYPASS(Bypass Mode), LINE(AC Mode), BAT(Battery Mode), BATT(Battery Self Test Mode), ECO(Economic mode), SHUTDN(Shutdown mode), CUCF(Constant Voltage and Constant Frequency Mode).

4.4 Single UPS turn On/Off operation

4.4.1 Turn on operation

➤ **Turn on the UPS on line mode**

- ① Once mains power is plugged in, the UPS will charge the battery, at the moment, LCD shows that the output voltage is 0, which means UPS has no output as default condition. If it is expected to have output of bypass, you can set the BPS "ON" by LCD setting menu.
- ② Press and hold the ON key for more than half a second to start the UPS, then it will start the inverter.
- ③ Once started, the UPS will perform a self-test function, and LED will light and go off circularly and orderly. When self-test finishes, it will come to online mode, the corresponding LED lights, UPS is working in line mode.

➤ **Turn on the UPS by DC without mains power**

- ① When main power is disconnected, press and hold the ON key for more than half a second to start UPS.
- ② The operation of UPS in the process of start is almost the same as that when mains power is on. After the self-test finishes, the corresponding LED lights and UPS are working in battery mode.

4.4.2 Turn off operation

➤ **Turn off the UPS in line mode**

- ① Press and hold the OFF key for more than half a second to turn off the UPS and inverter.

- ② After UPS shutting down, LED goes out and there is no output. If output is needed, you can set BPS "ON" on LCD setting menu.

➤ **Turn off the UPS in DC mode without mains power**

- ① Press and hold the OFF key for more than half a second to turn off the UPS.
- ② When turning off the UPS, it will do self-test first. LED lights go out circularly and orderly until there is no display on the panel.







4.5 Single UPS self-test/mute operation

- ① When UPS is in LINE Mode, press and hold the self-test/mute key for more than 1 second, LED light will go off circularly and orderly. UPS comes to self-test mode and tests its status. It will exit automatically after finishing test.
- ② When UPS is in BAT Mode, press and hold the self-test/mute key for more than 1 second, the buzzer stops beeping. If you press and hold the self-test/mute key for one more second, it will restart to beep again.

4.6 Single UPS panel function setting

UPS has setting function. After setting, it will become effective at once when meets some standards. The set information can be saved only when the battery connected and normally turning off the UPS.

4.6.1 ECO mode setting

- ① Enter the setting interface. Press and hold the function setting key  for more than 2 seconds, then come to setting interface, the letters "ECO" will flash;
- ② Enter the ECO setting interface. Press and hold the function setting key  for more than half a second (less than 2 seconds), then come to setting interface of ECO, at this time, the letters "ECO" will not flash any more. The "ON" (or OFF) will flash. Press and hold the inquiring key ( , ) for more than half a second (less than 2 seconds) to determine whether the ECO function is used or not. If used, the corresponding word is "ON", if not, the word is "OFF". It can be determined by yourself.
- ③ Confirm the ECO selecting interface. After selecting ON or OFF, press and hold the function setting key  for more than half a second (less than 2 seconds). Now, the ECO setting function is completed and the "ON" or "OFF" will light without flash.
- ④ Exit from the setting interface. Press and hold function setting key  for more than 2 seconds, exit from the setting interface and return to main interface.

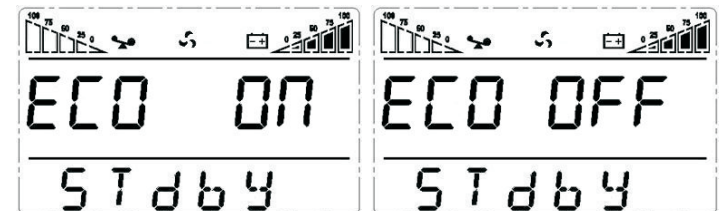

4.6.2 Bypass mode setting

- ① Enter the setting interface. Press and hold the function setting key \leftarrow for more than 2 seconds, then come to setting interface, press and hold the function setting key \leftarrow for more than half a second (less than 2 seconds), select the function setting, choose the bypass output interface, at the moment, the letters "BPS" will flash.
- ② Enter the Bypass output setting interface. Press and hold the function setting key \leftarrow for more than half a second (less than 2 seconds), then come to setting interface of BPS, at this time, the letters "BPS" will not flash any more. The "ON" letter will flash. Press and hold the inquiring key (\blacktriangleleft , \blacktriangleright) for more than half a second (less than 2 seconds) to determine whether the BPS function is used or not. If used, the corresponding word is "ON", if not, the word is "OFF". It can be determined by yourself.
- ③ Confirm the Bypass output setting interface. After selecting ON or OFF, press and hold the function setting key \leftarrow for more than half a second (less than 2 seconds), Now, the BPS setting function is completed and the "ON" or "OFF" will light without flash.
- ④ Press and hold the function setting key \leftarrow for more than 2 seconds, exit from the setting interface and return to main interface.
- ⑤ After setting BPS ON, without turning on the UPS whatever mains power being plugged in or not, there is bypass output but no backup function.

Note: For 6-10KVA UPS, can not set the bypass mode off, the default value is on.

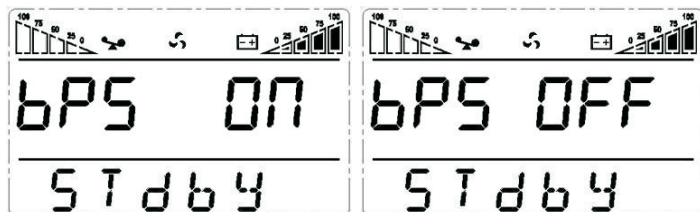

4.6.3 Output voltage setting

- ① Enter the setting interface. Press and hold the function setting key \leftarrow for more than 2 seconds, then come to setting interface, press and hold the inquiring key (\blacktriangleleft , \blacktriangleright) for more than half a second (less than 2 seconds), select the function setting, choose output voltage setting interface, at the moment, the letters "OPU" will flash.
- ② Enter the output voltage setting interface. Press and hold the function setting key \leftarrow for more than half a second (less than 2 seconds), then come to setting interface of output voltage OPU, at this time, the letters "OPU" will not flash any more. The numerical value next to the OPU will flash. Press and hold the inquiring key (\blacktriangleleft , \blacktriangleright) for more than half a second (less than 2 seconds), select the numerical value in accordance with "OPU" function. The provided voltages are 208V, 220V, 230V, 240V or 100V, 110V, 115V, 120V, 127V, you can choose anyone by yourself (The default value is 220V or 120V).
- ③ Confirm the output voltage setting interface. After selecting numerical value, press and hold the function setting key \leftarrow for more than half a second (less than 2 seconds). Now, the OPU setting function is completed and the numerical value will light without flash.
- ④ Press and hold function setting key \leftarrow for more than half a second (less than 2 seconds), exit from the setting interface and return to main interface.

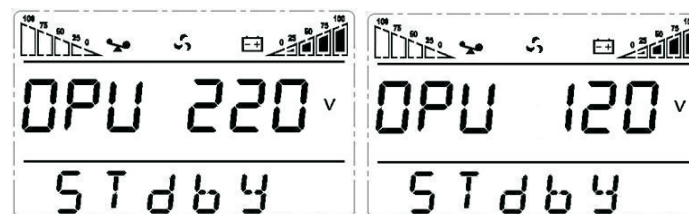

4.6.4 Low voltage of battery setting

- ① Enter the setting interface. Press and hold the function setting key \leftarrow for more than 2 seconds, then come to setting interface, Press and hold the inquiring key (\blacktriangleleft , \blacktriangleright) for more than half a second (less than 2 seconds), select the function setting, choose battery voltage setting interface, at the moment, the letters "bat" will flash.
- ② Enter the battery voltage selecting interface. Press and hold the function setting key \leftarrow for more than half a second (less than 2 seconds), then come to setting interface of battery voltage, this time, the numerical value will flash. Press and hold the inquiring key (\blacktriangleleft , \blacktriangleright) for more than half a second (less than 2 seconds), select the numerical value in accordance with "battery" function. The provided voltages are 10V, 10.2V, 10.5V, numbers stand for the voltage of each battery, you can choose anyone by yourself (The default is 10V), anyone has been chosen, under BAT mode, UPS will shutdown when its battery voltage achieve the voltage you chose.
- ③ Confirm the battery voltage selecting interface. After selecting numerical value, press and hold the function setting key \leftarrow , for more than half a second (less than 2 seconds). Now, the battery setting function is completed and the numerical value will light without flash.
- ④ Exit from the setting interface. Press and hold function setting key \leftarrow for more than half a second (less than 2 seconds), exit from the setting interface and return to main interface.

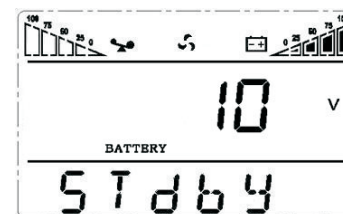

4.6.5 Frequency converter mode setting

- ① CUCF mode only can be set in STDBY mode. In STDBY mode, enter the setting interface. Press and hold the function setting key \leftarrow for more than 2 seconds, then come to setting interface, Press and hold the inquiring key (\blacktriangleleft , \blacktriangleright) for more than half a second (less than 2 seconds), select the function setting, choose battery voltage setting interface, at the moment, the letters "CF" will flash.
- ② Enter the CF setting interface. Press and hold the function setting key \leftarrow for more than half a second (less than 2 seconds), then come to setting interface of CF, at this time, the

letters "CF" will not flash any more. The "ON" (or OFF) will flash. Press and hold the inquiring key (◀ , ▶) for more than half a second (less than 2 seconds) to determine whether the CF function is used or not. If used, the corresponding word is "ON", if not, the word is "OFF". It can be determined by yourself.

- ③ Confirm the CF selecting interface. After selecting ON or OFF, press and hold the function setting key ↵ for more than half a second (less than 2 seconds). Now, the CF setting function is completed and the "ON" or "OFF" will light without flash.
- ④ Exit from the setting interface. Press and hold function setting key ↵ for more than 2 seconds, exit from the setting interface and return to main interface.
- ⑤ After setting CF at "ON", UPS would be back in STDBY Mode. The default value of CF is OFF.



4.6.6 Output frequency setting in CUCF mode

- ① Output frequency only can be set when CUCF mode is ON.
- ② In STDBY mode, enter the setting interface. Press and hold the function setting key ↵ for more than 2 seconds, then come to setting interface, Press and hold the inquiring key (◀ , ▶) for more than half a second (less than 2 seconds), select the function setting, choose battery voltage setting interface, at the moment, the letters "OPF" will flash.
- ③ Enter the OPF setting interface. Press and hold the function setting key ↵ for more than half a second (less than 2 seconds), then come to setting interface of OPF, at this time, the letters "OPF" will not flash any more. The "OFF" (or 50HZ, 60HZ) will flash. Press and hold the inquiring key (◀ , ▶) for more than half a second (less than 2 seconds) to determine whether the CF function is used or not. If used, select 50HZ or 60HZ according to you. It is determined by yourself, the default value is 50HZ.
- ④ Confirm the OPF selecting interface. After selecting 50HZ or 60HZ, press and hold the function setting key ↵ for more than half a second (less than 2 seconds). Now, the OPF setting function is completed and the "50HZ" or "60HZ" will light without flash.
- ⑤ Exit from the setting interface. Press and hold function setting key ↵ for more than 2 seconds, exit from the setting interface and return to main interface.

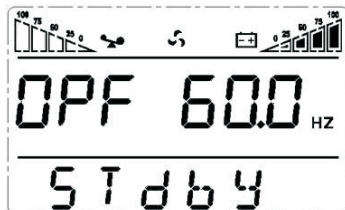

4.6.7 ID setting

- ① Enter the setting interface. Press and hold the function setting key ↵ for more than 2 seconds, then come to setting interface, press and hold the inquiring key (◀ , ▶) for more than half a second (less than 2 seconds), select the function setting, choose output voltage setting interface, at the moment, the letters "Id" will flash.
- ② Enter the output voltage setting interface. Press and hold the function setting key ↵ for more than half a second (less than 2 seconds), then come to setting interface of ID, at this time, the letters "Id" will not flash any more. The numerical value next to the "Id" will flash. Press and hold the inquiring key (◀ , ▶) for more than half a second (less than 2 seconds), select the numerical value. The provided ID numbers are 1, 2, 3, 4, 5, 6, 7, 8, you can choose anyone by yourself (The default value is 1).
- ③ Confirm the output voltage setting interface. After selecting numerical value, press and hold the function setting key ↵ for more than half a second (less than 2 seconds). Now, the ID setting function is completed and the numerical value will light without flash.
- ④ Exit from the setting interface. Press and hold function setting key ↵ for more than half a second (less than 2 seconds), exit from the setting interface and return to main interface.

Note: ID only can be set before doing parallel operation.



4.7 Parameters inquiring operation

Press and hold the inquiring key ◀ or ▶ for more than half a second (less than 2 seconds) to inquire about items. The inquired items include input, battery, output, load and temperature. The displayed items on LCD screen are showed as following:

➤ Output:

Display the output voltage and output frequency of the UPS. As the following pictures shows, the output voltage is 220V, the output frequency is 50Hz.

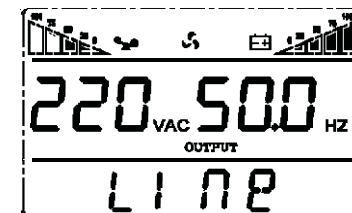

➤ **Load:**

Display the numerical value of the active power (WATT) and apparent power (VA) of the load. For example, as the following pictures shows: the WATT of the load is 9KW, VA is 10KVA (when disconnect load, it is a normal phenomenon to show a small numerical value of WATT and VA).

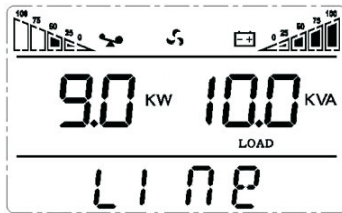

➤ **Temperature:**

Display the maximum temperature of the components in the UPS. As the following pictures shows: the maximum temperature is 40°C.

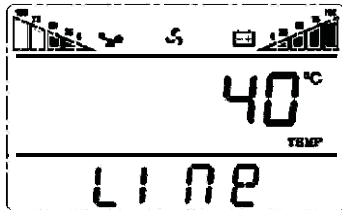

➤ **Input:**

Display the voltage and frequency of the input. As the following pictures shows: the input voltage is 220V, input frequency is 50Hz.

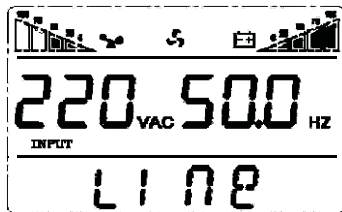

➤ **Battery:**

Display the voltage and capacity of the battery (determined by type). As the following pictures shows: the battery voltage is 192V, the capacity of battery is 100% (the capacity of battery is approximately reckoned according to the battery voltage).

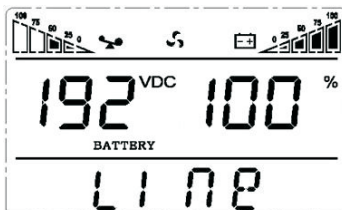

Press and hold the inquiring key ◀ for more than 2 seconds, LCD begins to display the items circularly and orderly which transfer to another every 2 seconds. Press and hold the key for some time again within 30s, it will return to output status.

5 Working mode introduction

5.1 Bypass mode

LED indications on front panel in bypass mode are as following:



Bypass yellow LED is on, the buzzer beeps once every 2 minutes. The warning red LED is on when beeping, what LCD displays depending on the exact load and battery capacity.

Turn to bypass mode under the following two conditions:

- ① Turn off the UPS line mode while start the bypass output.
- ② Overload in line mode.

Note: When UPS is working in bypass mode, it has no back up function.

5.2 Line mode

LED indications on front panel in line mode or CUCF mode are as following: The inverter green LED is on.



When input AC mains correspond to the working conditions, UPS will work in line mode.

5.3 Battery mode

LED indications on front panel in battery mode are as following: both the inverter green LED and battery yellow LED is on, the buzzer beeps once every 4 seconds. The warning red LED will be on while beeping.



When the mains power is low or unstable, UPS will turn to battery mode at once.

5.4 ECO mode

LED indications on front panel in ECO mode are as following: both the inverter green LED and bypass yellow LED are on.



When the input mains meets the input range of the ECO mode and the ECO function is on, the UPS will works in ECO mode. If input AC mains exceed the range of ECO several times within one minute but stays in inverter input range, UPS will work in AC inverting mode automatically.

5.5 Fault mode

LED indications on front panel in Fault mode are as following: warning red LED is on and LCD display fault code and related icon.



Fault mode (LCD interface on which the fault code display)

When UPS has faulted. The warning LED is on and the buzzer beeps. UPS will turn to fault mode. UPS cuts off the output and LCD display fault codes. At the moment, you can press the mute key to make the buzzer stop beeping temporarily to wait for maintenance. You can also press the OFF key to shut down the UPS when confirmed that there is no serious fault.

6 The warning code list of the LED light and display panel

Appendix 1: The table of the fault code

| Fault code | Fault type | Bypass output | Note |
|---------------------|--------------------------|---------------|--------|
| 0、1、2、3、4 | Bus high | yes | |
| 5、6、7、8、9 | Bus low | yes | |
| 10、11、12、13、14 | Bus unbalance | yes | |
| 15、16、17、18、19 | Bus soft start fail | yes | |
| 20、21、22、23、24 | Inverter soft start fail | yes | |
| 25、26、27、28、29 | Inverter high | yes | |
| 30、31、32、33、34 | Inverter low | yes | |
| 35、36、37、38、39 | Bus discharge fail | yes | |
| 40、41、42、43、44 | Over heat | yes | |
| 45、46、47、48、49 | OP(inverter) short | no | |
| 50、51、52、53、54 | Overload | yes | |
| 55、56、57、58、59 | Line NTC break | yes | |
| 60、61、62、63、64 | Shutdown fault | yes | |
| 65、66、67、68、69 | AC input fuse open | yes | unused |
| 70、71、72、73、74 | Communication fault | yes | unused |
| 75、76、77、78、79 | Communication fault | yes | |
| 80、81、82、83、84 | Relay fault | yes | |
| 85、86、87、88、89 | AC input SCR fault | yes | unused |
| 90、91、92、93、94 | CAN fault | yes | |
| 95、96、97、98、99 | ID conflict | yes | |
| 100、101、102、103、104 | Incompatible type | no | |

Appendix 2: Table for working status

| S/N | Working status | LED on Front panel | | | | Alarm beep | Note |
|----------|---|--------------------|---------|--------|-------|-----------------|------|
| | | Normal | Battery | Bypass | Fault | | |
| 1 | Inverter mode (mains power) | | | | | | |
| | Mains power voltage | ● | | | | N | |
| | Mains power high/low voltage protection, switch to battery mode | ● | ● | | ★ | One beep/4 sec | |
| 2 | Battery mode | | | | | | |
| | Battery voltage - normal | ● | ● | | ★ | One beep/4 sec | |
| | Warning for abnormal voltage of battery | ● | ★ | | ★ | One beep/sec | |
| 3 | Bypass mode | | | | | | |
| | Mains power – normal (under Bypass) | | | ● | ★ | One beep/2 mins | |
| | Mains power – high voltage warning (under Bypass) | | | ● | ★ | One beep/4 sec | |
| | Mains power – low voltage warning (under Bypass) | | | ● | ★ | One beep/4 sec | |
| 4 | Warning for battery disconnected | | | | | | |
| | Bypass mode | | | ● | ★ | One beep/4 sec | |
| | Inverter mode | ● | | | ★ | One beep/4 sec | |
| | Power on/Switch on | | | | | 6 beeps | |
| 5 | Output overload protection | | | | | | |
| | Warning for mains power overload | ● | | | ★ | 2 beeps/sec | |
| | Protect operation for mains power mode overload | | | ● | ● | Long beep | |
| | Warning for battery overload | ● | ● | | ★ | 2 beeps/sec | |
| | Protect operation for battery mode overload | ● | ● | | ● | Long beep | |
| 6 | Warning for bypass mode overload | | | ● | ★ | One beep/2 sec | |
| 7 | Fans fault(fan icon) | ▲ | ▲ | ▲ | ★ | One beep/2 sec | |
| 8 | Faults mode | | | | ● | Long beep | |

● LED indicator lights long time ★ LED indicator flicker ▲ LED indicator status depends on other conditions

Note: End user need to provide below information when require to maintain the UPS.

- UPS Model No. & Serial No.
- Date of fault occurrence.
- Fault detail (LED status, noise, AC power situation, load capacity, for long back up type, battery capacity configuration is also necessary.)

7 Trouble shooting

When the system runs in failure mode, the LCD will show as below:

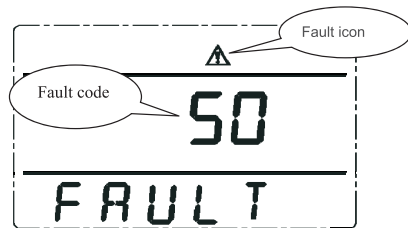

Explicit Troubleshoot Introduction Sheet

| Trouble indication | Failure point | Solution |
|---|-------------------------|---|
| Fault LED on, audible buzzer Persistently alarm, the fault code is 00-14 | Bus bar voltage fault | Please test the bus bar voltage or contact the supplier. |
| Fault LED on,audible buzzer persistently alarm,the fault code is 15-24 | Soft start fault | Please check the soft start up circuit, especially the soft start resistance or contact the supplier directly. |
| Fault LED on,audible buzzer persistently alarm,the fault code is 25-39 | Inverter voltage fault | Please contact the supplier. |
| Fault LED on,audible buzzer persistently alarm,the fault code is 40-44 | Over temperature inside | Please make sure the UPS didnt get overload,and the fan vent was not obstructed,as well as the indoor temperature is not high. Leave alone the UPS 10 minutes for cooling, and restart it. If failure remains, please contact the supplier. |
| Fault LED on, audible buzzer Persistently alarm, the fault code is 45-49 | Output short-circuit | Turn of the UPS and disconnect all the load, make sure there no any fault or internal short circuit of the load. And then restart the UPS, if failure still, please contact the supplier. |

| | | |
|---|--|---|
| Fault LED on,audible buzzer persistently alarm,the fault code is 50-54 | Over load | Please check the load level and disconnect the noncritical devices, recount the total capacity of your load and reduce the load to the UPS. Please check whether the load device has fault or not? |
| Fault LED on,audible buzzer persistently alarm, the fault code is 55-59 | Input NTC fault | Please contact the supplier. |
| Fault LED on, audible buzzer persistently alarm,the fault code is 60-64 | Power fault | Please Check whether the input & output power normal or not, contact the supplier if it is abnormal. |
| Fault LED on,audible buzzer persistently alarm, the fault code is 65-69 | Input fuse fault | Please check if the input fuse is burnt. Replace the old fuse and restart the UPS. If failure remains, please contact the supplier. |
| Fault LED on,audible buzzer Persistently alarm, fan icon in the LCD flickers | Fan fault | Please check whether the fans connect well, is the fan plugged and is the fan broken? If all above condition is ok, please contact the supplier. |
| UPS fail to start when operate "On" key | Pressing time too short | Please press the power key more than 2 seconds to start the UPS. |
| | The input connection is not ready or UPS internal battery disconnect | Please connect the input well, if the battery voltage is too low,please disconnect the input and start the UPS with no-load. |
| | UPS internal system fault | Please contact the supplier. |
| Back up time become short | Battery undercharge | Please keep the UPS battery recharging more than 3 hours. |
| | UPS overload | Please check the load level and disconnect the noncritical devices. |
| | Battery maturing, capacity descend | Please change new battery,contact your supplier to get the new battery and spare parts. |
| UPS doesn't have any power go through even main power on | UPS input breaker disconnects | Please reset the circuit breaker by manual. |



Attention:

When the output is short-circuited, the action of the protection of the UPS will show up. Before turning off the UPS, please make sure to disconnect the entire load and cut off the AC mains power supply, otherwise will make the AC input short-circuit.

Appendix 1: EMC Level

The series product is designed to meet the below standard.

| EMS | |
|-------------------------|---------|
| IEC61000-4-2(ESD) | Level 4 |
| IEC61000-4-3(RS) | Level 3 |
| IEC61000-4-4(EFT) | Level 4 |
| IEC61000-4-5(Surge) | Level 4 |
| EMI | |
| GB9254-1998/IEC 62040-2 | Class B |

Appendix 2: Symbol instructions:

| Symbols and significations | | | |
|----------------------------|-----------------------|--------|---------------------------|
| Symbol | Significations | Symbol | Significations |
| | Caution | | Protect grounding |
| | Danger! High Voltage! | | Alarm cancel |
| ON | Turn on | | Overload |
| OFF | Turn off | | Battery inspection |
| | Standby or Shutdown | | Repeat |
| | AC | | Display screen repeat key |
| | DC | | Battery |

Appendix 3: Specification Sheet (1-3KVA)

| Rated Capacity | 1KVA | 1.5KVA | 2KVA | 3KVA |
|---|---|---|-----------|-----------|
| Input | | | | |
| Rated input voltage | 220V or 120V | | | |
| Rated input frequency | 50Hz/60Hz auto-adaptive | | | |
| Input voltage range (the type of 220V) | (115~295)±5VAC (half load) (145~295)±5VAC(full load) | | | |
| Input voltage range (the type of 120V) | (55~145) ±5VAC(60% LOAD); (65~145) ±5VAC(70% LOAD) (75~145) ±5VAC(80% LOAD); (85~145) ±5VAC(100% LOAD) | | | |
| Input frequency range | 45-55Hz+/-0.5% 50Hz type | | | |
| | 55-65Hz+/-0.5% 60Hz type | | | |
| Input current | 220V | 8A max | 12A max | 15A max |
| | 120V | 14A max | 21A max | 27A max |
| PFC | ≥0.98 | | | |
| THDI | <6% | | | |
| Bypass voltage range | 220V | Rated output voltage -34V ~ Rated output voltage +32V | | |
| | 120V | (95~135) ±5VAC | | |
| Output | | | | |
| Output voltage | 220V | 208VAC/220VAC/230VAC/240VAC Setting available via LCD | | |
| | 120V | 100/110/115/120/127VAC Setting available via LCD | | |
| Output PF | 0.8/0.9 | 0.8/0.9 | 0.8/0.9 | 0.8/0.9 |
| Output power(Watt) | 800/900 | 1200/1350 | 1600/1800 | 2400/2700 |
| Inverter overload capability | 105%~150%: transfer to bypass mode after 30s giving alarm; >150% : transfer to bypass mode after 300ms giving alarm; | | | |
| Voltage accuracy | ±1% | | | |
| Load crest | 3:1 | | | |
| From AC mode to BAT mode | 0ms(transfer time) | | | |
| From BAT mode to AC mode | 0ms(transfer time) | | | |
| Efficiency | Line mode | ≥90% | | |
| | BAT mode | 87% | | |
| | ECO mode | 94% | | |
| Output frequency | | | | |
| Under Mains mode | Same as input frequency | | | |
| Under battery mode | (50/60±0.2)Hz | | | |
| Phase-locked rate | ≤1Hz/s | | | |
| Total voltage harmonic distortion | Full linear load<3%; Full nonlinear load<5% | | | |
| Battery | | | | |
| Battery type | Sealed lead acid maintenance free battery | | | |
| Quantity | 2 | 3 | 4 | 4 |
| DC voltage | 24V | 36V | 48V | 48V |
| Inbuilt battery | 9AH/12V | 7AH/12V | 9AH/12V | 9AH/12V |
| Output voltage | 27.1±0.4V | 40.6±0.5V | 54.2±0.6V | 54.2±0.6V |
| Back up time | Based on battery capacity | | | |
| Charge method | Three-stage charging | | | |
| Charge current | Standard model:1A | | | |
| | Long time model: 6A | | | |
| System Control and Communication | | | | |
| Function | Silence; cold start; AC restart; Auto restart. | | | |

| | |
|--------------------|---|
| Protection | Over-temp protection; Fan testing protection; AC L and N reversely connecting protection; Output short circuit protection |
| Communication port | RS232; SNMP card; USB |
| Software function | Graphics analyze; Switch on/off UPS system; Monitor UPS working status; History record and event log |
| Display | LCD/LED |

Appendix 4: Specification Sheet (6-10KVA)

| Rated Capacity | 6KVA | 10KVA |
|-----------------------------------|---|---|
| Input | | |
| Rated input voltage | 220V | |
| Rated input frequency | 50Hz/60Hz auto-adaptive | |
| Input voltage range | (115~295)±5VAC (half load); (165~295)±5VAC(full load) | |
| Input frequency range | 40~70Hz, ±0.5% | |
| Input current | 46A max | 76A max |
| PFC | ≥0.99 | |
| THDI | <5% | |
| Bypass voltage range | 160V ~ Rated output voltage +32V | |
| Output | | |
| Output voltage | 220V | 208VAC/220VAC/230VAC/240VAC Setting available via LCD |
| | 120V | 100/110/115/120VAC Setting available via LCD |
| Output PF | 0.9 | |
| Output power(Watt) | 5400 | 9000 |
| Inverter overload capability | 105%~125%: 3 mins; 125%~150%: 30 secs; >150%: 100ms; | |
| Voltage accuracy | ±1% | |
| Load crest | 3:1 | |
| From AC mode to BAT mode | 0ms(transfer time) | |
| From BAT mode to AC mode | 0ms(transfer time) | |
| Efficiency | Line mode | ≥92% |
| | BAT mode | ≥91% |
| | ECO mode | ≥98% |
| Output frequency | | |
| Line mode | Same as input frequency | |
| BAT mode | (50/60±0.2)Hz | |
| CUCF mode | (50/60±0.2)Hz | |
| Phase-locked rate | ≤1Hz/s | |
| Total voltage harmonic distortion | Full linear load < 2%; Full nonlinear load < 5% | |
| Battery | | |
| Battery type | Sealed lead acid maintenance free battery | |
| Quantity | 16 | |
| DC voltage | 192V | |
| Charger output voltage | 216.8±1V | |
| Inbuilt battery | 7AH/12V | 9AH/12V |
| Charge method | Three-stage charging | |
| Back up time | Based on battery capacity | |
| Charge current | Standard model:1A | |
| | Long-run model: 1A /3A /5A /8A | |

| System Control and Communication | |
|----------------------------------|---|
| Function | Silence; cold start; AC restart; Auto restart. |
| Protection | Over-temp protection; Fan testing protection; AC L and N reversely connecting protection; Output short circuit protection |
| Communication port | RS232; SNMP card; USB; Dry contact |
| Software function | Graphics analyze; Switch on/off UPS system; Monitor UPS working status; History record and event log |
| | LCD/LED |

* Derate capacity to 70% in CUCF mode and to 90% when the output voltage is adjusted to 208VAC.

Appendix 5: Physical (The type of 220V)

| Rated Capacity | 1KVA | 1.5KVA | 2KVA | 3KVA |
|---------------------|-------------|-------------|-------------|-------------|
| Quantity of Battery | 2 | 3 | 4 | 6 |
| Dimension (W*D*H) | 144*357*215 | 144*410*215 | 190*452*341 | 190*452*341 |
| Weight (Kg) | Long | 6 | 10 | 12 |
| | Standard | 10 | 13.5 | 18 |

| Rated Capacity | 6KVA | 6KVA-Isolated | 10KVA | 10KVA-Isolated |
|-----------------------------------|----------|---------------|-------------|----------------|
| Containing isolation transformers | No | Yes | No | Yes |
| Dimension (W*D*H) | Long | 262*514*455 | 262*514*455 | 262*514*455 |
| | Standard | 262*514*735 | 262*514*735 | 262*514*735 |
| Weight (Kg) | Long | 26 | 47 | 26 |
| | Standard | 67 | 80 | 67 |

Appendix 6: Physical (The type of 120V)

| Rated Capacity | 1KVA | 1.5KVA | 2KVA | 3KVA |
|-------------------|----------|-------------|-------------|------|
| Dimension (W*D*H) | Long | 144*357*215 | 190*452*341 | |
| | Standard | 144*357*215 | 190*452*341 | |
| Weight (Kg) | Long | 6 | 12 | 13 |
| | Standard | 11 | 22 | 28 |