

# User Manual

## Line-interactive UPS Pure Sine Wave

500VA/1000VA/1500VA/2000VA/3000VA

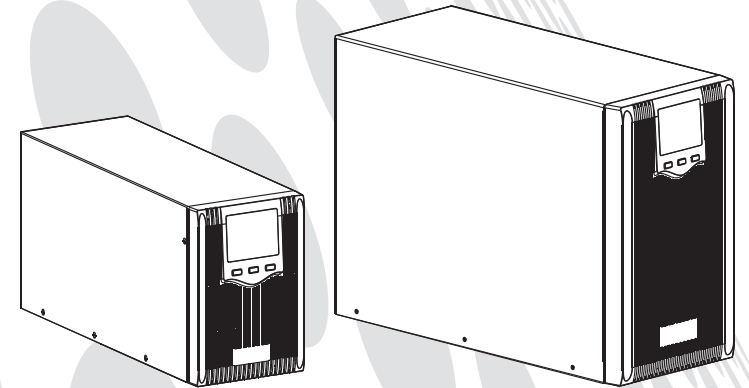

# Table of Contents

<b>1 Safety Information</b> .....	<b>2</b>
<b>2 Product Overview</b> .....	<b>4</b>
2.1 Specifications .....	4
2.2 Front panel features .....	7
2.2.1 Tower panel.....	7
2.2.2 SRT panel.....	7
2.3 Rear panel features .....	7
2.3.1 Tower rear panel.....	7
2.3.2 SRT rear panel .....	8
<b>3 Installation</b> .....	<b>9</b>
3.1 Unpacking inspection .....	9
3.2 Installation information.....	9
3.2.1 Safety precautions .....	9
3.2.2 Tower installation.....	10
3.2.3 Long backup model UPS installation .....	11
3.2.4 SRT installation.....	12
<b>4 Operation</b> .....	<b>14</b>
4.1 Buttons operation .....	14
4.2 LED Indicator light .....	15
4.3 LCD display interface .....	15
4.4 UPS On/Off operation.....	17
4.4.1 Turn on the UPS.....	17
4.4.2 Turn off the UPS.....	18
4.5 Parameter query operation.....	18
<b>5 UPS Settings</b> .....	<b>20</b>
<b>6 Troubleshooting</b> .....	<b>24</b>
6.1 Fault messages .....	24
6.2 Common faults and processing.....	25
<b>7 Maintenance</b> .....	<b>26</b>
7.1 Preventive maintenance .....	26
7.2 Battery maintenance.....	26

# 1 Safety Information

- Please charge the product for more than 8 hours before using.
- When the battery has been discharged or the storage period has been more than 3 months, the battery shall be charged for more than 8 hours in time, so as to ensure it is fully-charged and prevent it from being damaged.
- This product is specially designed for group computers. It shall not be connected with inductive loads (e.g. motor, refrigerator, etc.). It is not recommended for life supporting system and other specific major equipments;
- Keep a distance of at least 50 cm from the display during installation of the product.
- It's normal for the surface temperature of the cabinet may rise to 50°C during use of the product.
- Do not overload the product.
- Do not open the cabinet of the UPS due to hazard of electrical shock, Contact your local service center if maintenance or repair is needed.
- UPS inner short circuit will cause electric shock or fire danger. Do not put any liquid vessel on the UPS.
- Cut off the power supply rapidly if the UPS work abnormal, and contact your local dealer.
- Make sure not to keep or use the product in following environment.
  - No good air circulation
  - Place having flammable gas or corrosive material or lots of dust
  - Place under abnormal high or low temperature (above 40°C or below 0°C), or high humidity (above 90%)
  - Place where there is direct sunlight or near the heating appliance
  - Place where there is violent vibration
  - Outdoor
- Do not use liquid extinguisher if there is a fire, a dry powder extinguisher is recommended.
- Place the UPS near the mains source so that can cut off utility power without any delay in case of emergency.
- When the UPS is to be moved or reconnected, ensure that the AC input power supply is cut off and the UPS is completely turned off, otherwise the output end may be electrified and result in electric shock.
- The battery life is shortened as the ambient temperature rises. Periodic battery replacement can ensure UPS working properly and enough backup time.
- The battery maintenance shall only be carried out by the personnel having professional

knowledge of batteries.

- Batteries may cause electric shocks and have a high short circuit current, follow below requirements before installing or replacing the batteries:
  - Remove wristwatches, rings, jewelry and other conductive materials
  - Only use tools with insulated grips and handles
  - Wear rubber shoes and gloves
  - Do not put the metal tools or paSRT on the batteries
  - Before disconnecting the terminals from the batteries, cut off all the loads to the batteries first
- Do not short circuit the positive and negative terminals of batteries, otherwise it may result in electric shocks or fire.
- If need to extend the backup time of the standard model UPS (external battery), loading capacity should be reduced to 50%.

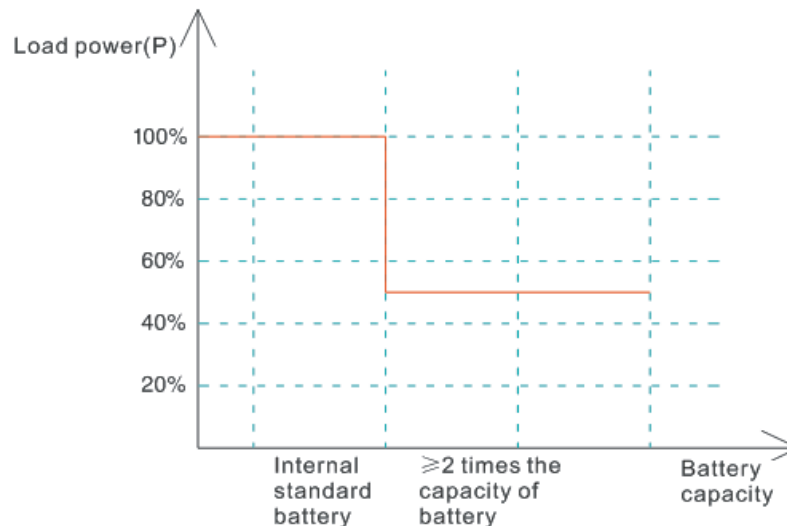

 **Warning**

- The equipment must be grounded. When utility power is connected, the system must be grounded reliably.
- Improper operation will result in huge losses. Please be sure to operate the product according to the requirements of the user manual.
- UPS should be used at an altitude below 1,000 m. If use it at an altitude of more than 1,000 m , derating output is required, as shown in below table:
- Load capacity at a high altitude location = rated power \*derating coefficient (Corresponding to the altitude).

Altitude (m)	1000	1500	2000	2500	3000	3500	4000	4500	5000
Derating coefficient	100%	95%	91%	86%	82%	78%	74%	70%	67%

## 2 Product Overview

### 2.1 Specifications

Model	500VA (H)	1000VA (S/H/SRT)	1500VA (S/SRT)	2000VA (S/H/SRT)	3000VA (S/H/SRT)
<b>DC input</b>					
Rated voltage	12V	24V		36V (H: 48V)	48V
DC input range (default)	10-15 V	20-30V		S: 30-45V H: 40-60V	40-60V
<b>AC input</b>					
AC input range (bypass mode)	0 - 121V / 132V / 138V / 144Vac for 100Vac / 110Vac / 115Vac / 120Vac ± 10Vac; 0 - 242V / 264V / 276V / 288 Vac for 200Vac / 220Vac / 230Vac / 240Vac ± 10Vac,				
AC input range (utility mode)	100V: 70 - 130 Vac, 110V: 80 - 140Vac, 115V: 85 - 145Vac, 120V: 90 - 150Vac, 200V: 145 - 260Vac, 220V: 165 - 280V, 230V: 175 - 290Vac, 240V: 185 - 300Vac;				
Frequency input range	50 Hz / 60 Hz (auto-sense), 50 Hz/ 60 Hz ± 5% - 15%				
Generator connection	Yes (Generator input power is settable)				
<b>Output</b>					
Inverter output range	200Vac / 220Vac / 230 Vac / 240 Vac ± 5% (settable) ; 100 Vac / 110 Vac / 115Vac / 120 Vac ± 5% (settable)				
AC output range (bypass mode)	0-121V / 132V / 138V / 144Vac for 100Vac / 110Vac / 115Vac / 120Vac ± 10Vac; 0 - 242V / 264V / 276V / 288Vac for 200Vac / 220Vac / 230Vac / 240 Vac ± 10Vac,				
AC output range (utility mode)	100V: 90 - 110Vac, 110V: 99 - 121Vac, 115V: 103 - 126Vac, 120V: 108 - 132Vac, 200V: 166 - 226Vac, 220V: 188 - 245Vac, 230V: 199 - 254Vac , 240V: 210 - 264Vac				
Output frequency	50 Hz / 60 Hz ± 0.3 Hz (settable)				
Waveform	Pure sine wave				
Power	300W	800W	1200W	1600W	2400W
Power factor	0.6	0.8			
Inverter efficiency	Max. 75%	Max. 80%		Max. 85%	
Energy saving mode	Settable (< 3 % load) , enter in 80 s				
No-load shutdown	Settable (< 3 % load), shut down in 80 s				
Transfer time	≤ 10 ms				
THDV	≤ 5%				

(resistive load)					
Inductive load	Yes				
Capacitive load	Yes				
Resistive load	Yes				
Protection	Overload, short circuit (inverter), battery low voltage, battery overcharge, overtemperature				
Overload time (utility mode)	110 % 120 s; 125 % 60 s; 150 % 10 s (transfer to bypass mode)				
Overload time (inverter mode)	110 % 60 s; 125 % 10 s; 150 % 5 s (Shut down directly)				
Mute	Automatic mute in 60 s or by manual				
<b>Batteries</b>					
Battery capacity (H: external expansion)	12V*1	12V/7AH *2	12V/9AH* 2	12V/9AH*3 ( H: 12V*4 )	12V/9AH*4
Charging current	Standard model (S): 1 A (default) Long backup model (H): 10 A (default), < 10 A, set step = 1 A, ≥ 10 A, set step = 5 A				
	H: Max. 10 A	H: Max. 15 A	----	H: Max. 20 A	H: Max. 25 A
Equalizing charge voltage	Single battery 14.1 Vdc (default), 13.6 - 15 Vdc adjustable				
Floating charge voltage	Single battery 13.5 Vdc (default), 13.2 - 14.6 Vdc adjustable				
Low voltage alarm point	Single battery 10.8 Vdc (default), 9.6 - 13 Vdc adjustable				
Low voltage shutdown point	Single battery 10.2 Vdc (default), 9.6 - 11.5 Vdc adjustable				
<b>Alarms</b>					
Power On / Off state change	Beep continuously for 0.5 s (one beep)				
Battery low voltage	Beep continuously for 0.16 s, with an interval of 0.16 s (quick)				
Overload	Beep continuously for 2 s, with an interval of 0.5 s (long beep)				
Utility power failure	Beep continuously for 0.32 s, with an interval of 0.5 s (slow)				
<b>Others</b>					

Interface	LCD & Buzzer				
Operating temperature	5°C - 40°C				
Operating humidity	Relative humidity ≤ 93%				
Cooling mode	Fan				
<b>Tower UPS</b>					
Dimensions (W×D×H) (mm)	144×345×215 (S / H)			144× 410×215 (S) 144× 345×215 (H)	190×467×335.5 (S / H)
Packaged dimensions (W×D×H) (mm)	236×427×316 (S / H)			236×492×316 (S) 236×427×316 (H)	320×592×462 (S / H)
Net weight (Kg)	7.0 (H)	12.2 (S) 11.6 (H)	14.2 (S)	18.5 (S) 17.8 (H)	28.1 (S) 28.0 (H)
Gross weight (Kg)	8.0 (H)	13.2 (S) 12.6 (H)	15.2 (S)	19.8 (S) 18.8 (H)	30.2 (S) 30.0 (H)
<b>SRT UPS</b>					
Dimensions (W×D×H) (mm)	--	440×338×88 (S)	440×410×132 (S)		
Packaged dimensions (W×D×H) (mm)	--	611×448×208 (S)	611×505×235 (S)		
Net weight (Kg)	--	14.6 (S)	17.2 (S)	21.3 (S)	26.7 (S)
Gross weight (Kg)	--	16.8 (S)	20.4 (S)	24.5 (S)	30.5 (S)

**Note:**

- “S” means standard model, “H” means long backup model, “SRT” means rack-mount standard model.
- The above products are normal products of the company. Special customized model shall be subject to the real product.
- The discharge time is related to the configured battery capacity and load characteristics, subject to the configuration of the real product.
- UPS can work normally only after connecting it to the battery.

## 2.2 Front panel features

### 2.2.1 Tower panel

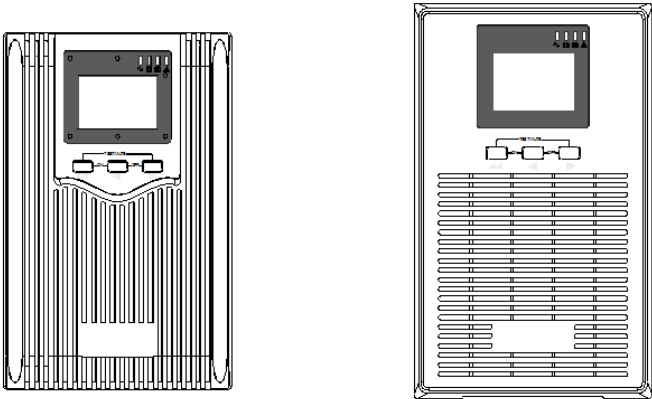

Fig. 2.2.1 panel "Smart" (left)

panel "A" (right)

### 2.2.2 SRT panel

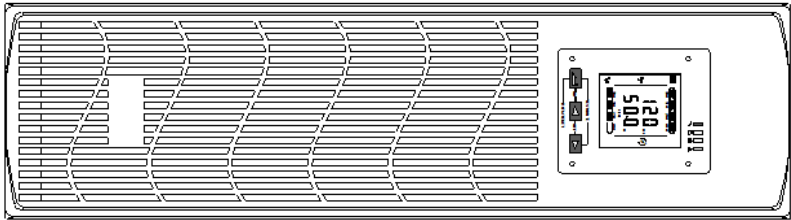

Fig. 2.2.2 SRT panel

## 2.3 Rear panel features

### 2.3.1 Tower rear panel

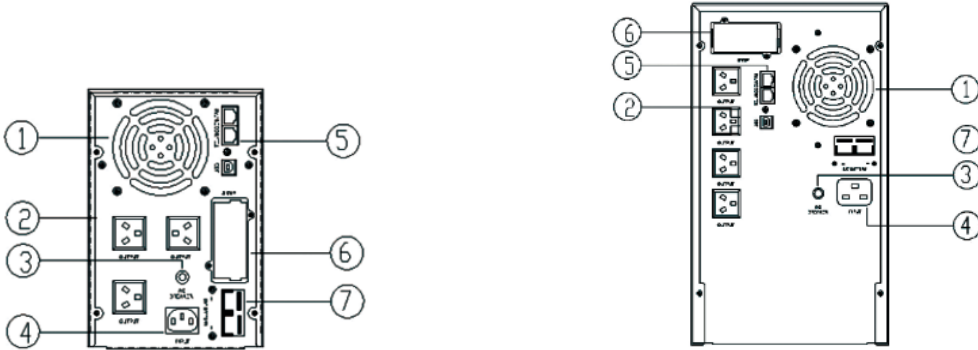

Fig. 2.3.1 500VA - 2KVA rear panel

3KVA rear panel



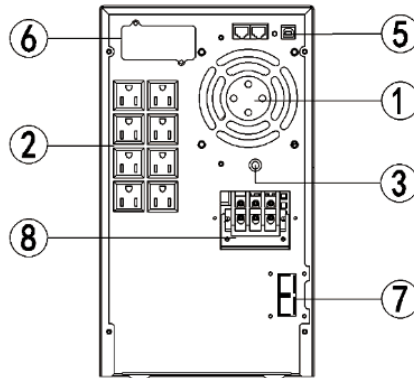

Fig. 2.3.1 3KVA 100V - 120V rear panel

### 2.3.2 SRT rear panel

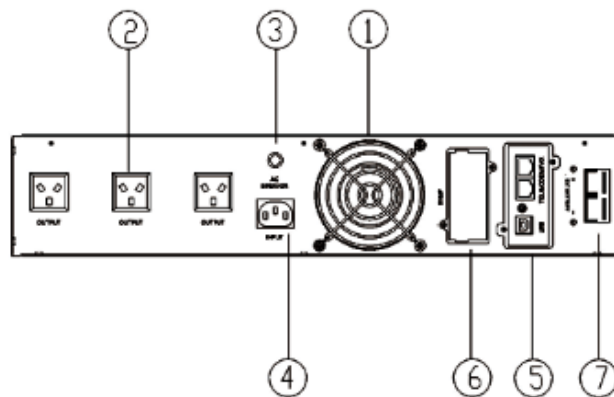

Fig. 2.3. 2 2KVA 2U SRT rear panel

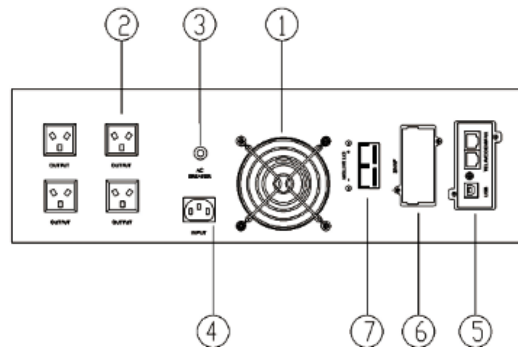

Fig. 2.3. 2 1.5KVA - 3KVA 3U SRT rear panel

Description of rear panel:

① Fan and fan guard	⑤ Communication interface (standard configuration: USB + RJ45)
② Output socket	⑥ SNMP card slot
③ AC over-current protector	⑦ External battery connector
④ IEC Input socket	⑧ Input / output terminal board

## 3 Installation

### 3.1 Unpacking inspection

- Open the UPS package and inspect the contents upon receipt. The accessories attached to the UPS contains a power cord, a user manual, communication cable, CD-ROM, a battery connection cable (not available for standard model UPS); 2 pairs stabilizer brackets ( for SRT UPS only, not available for tower UPS), wall mounting brackets (for SRT UPS only, not available for tower UPS), Others is according to requirements of the contract.
- Check if the unit is damaged during transport. Do not power on and notify the carrier and dealer if find damaged or paSRT missing.
- Verify this unit is the model you want to buy. Check the model name showed on the cover plate.

**Note:**

Keep the packaging box and packaging materials for future transport use. The equipment is heavy. Always handle it with care.

### 3.2 Installation information

#### 3.2.1 Safety precautions

- The UPS installation environment must be in good ventilation. A minimum clearance of 150mm at the sides and top must be maintained. And Keep away from water, flammable gases and corrosive entities.

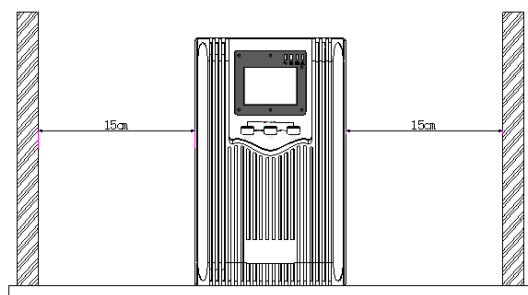

- Turn off the devices which need UPS supply power (such as host computer), disconnect the power cord from the utility power socket and connect it to the output socket of UPS; connect the devices which do not need to be connected to the UPS to the common utility power socket.
- The UPS input is plugged into the utility power socket (ensure the neutral wire (N) and live wire (L) are correct and the earth wire (E) is good).

- The ambient temperature of UPS should be kept between 0°C and 40°C;
- It is recommended to charge the battery for 8 hours before using it. The UPS will charge the battery automatically as long as the input utility power is connected to the host.
- For the long backup model UPS, do not connect the utility power until verify that the battery connection is done.

### Warning:

In order to avoid damage to equipment or personnel, the equipment should be installed by qualified personnel.

### 3.2.2 Tower installation



Fig. 3.2.2 Tower 500VA - 2KVA input/output connection diagram

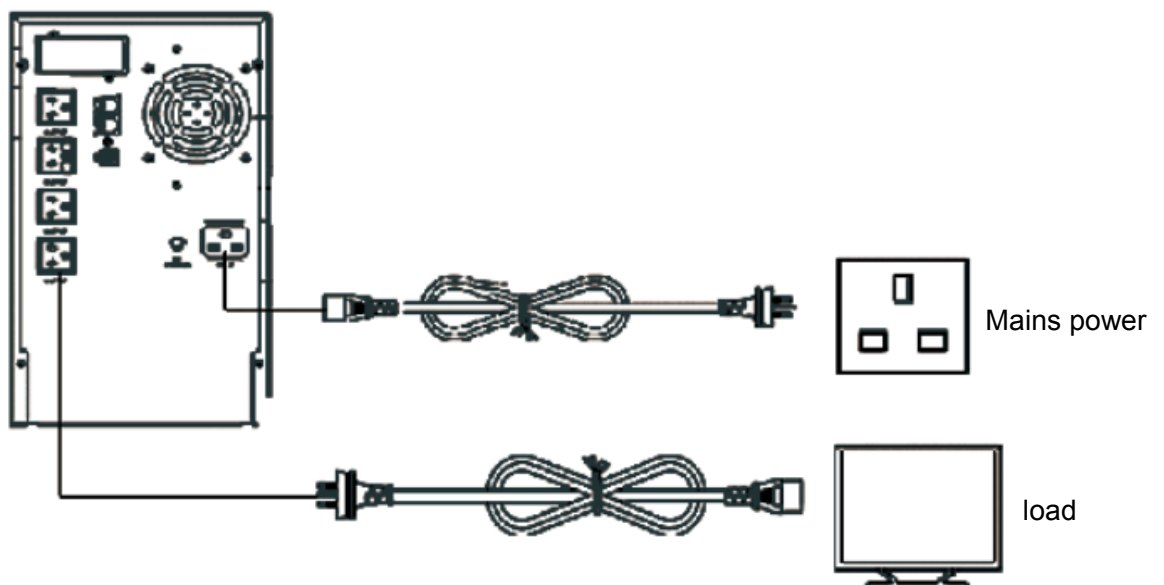

Fig. 3.2.2 Tower 3KVA input / output connection diagram

### 3.2.3 Long backup model UPS installation

- Firstly connect the battery bank with attached battery cables (note: the red cable should be connected to the anode, and the black cable should be connected to the cathode).
- Verify the connection of the battery bank with a multimeter.
- Verify if the installation is correct after finishing installation.

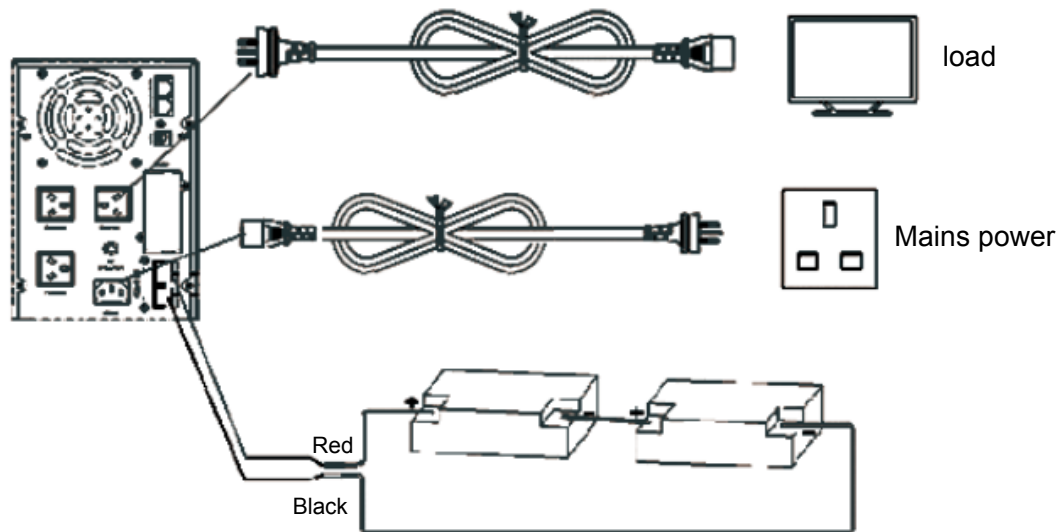

Fig. 3.2.3 Tower DC 24V input / output connection diagram

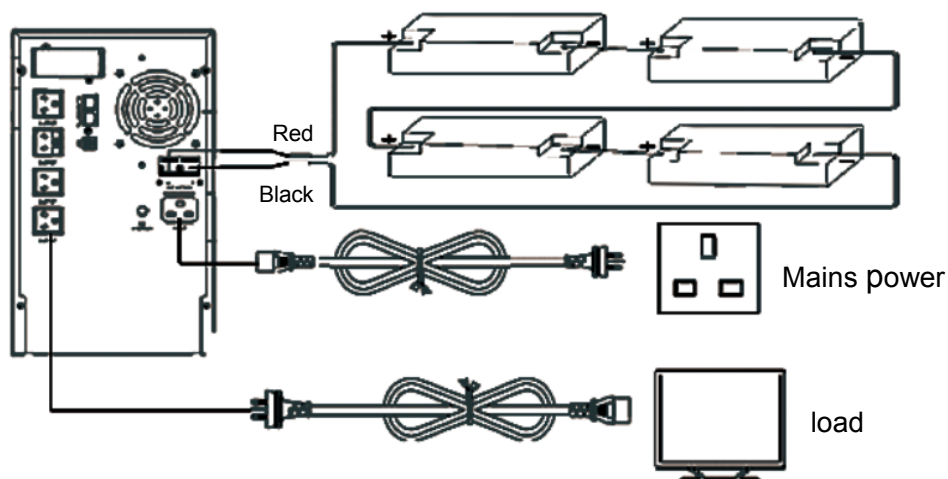

Fig. 3.2.3 Tower DC 48V input / output connection diagram

### 3.2.4 SRT installation

#### 3.2.4.1 Wiring

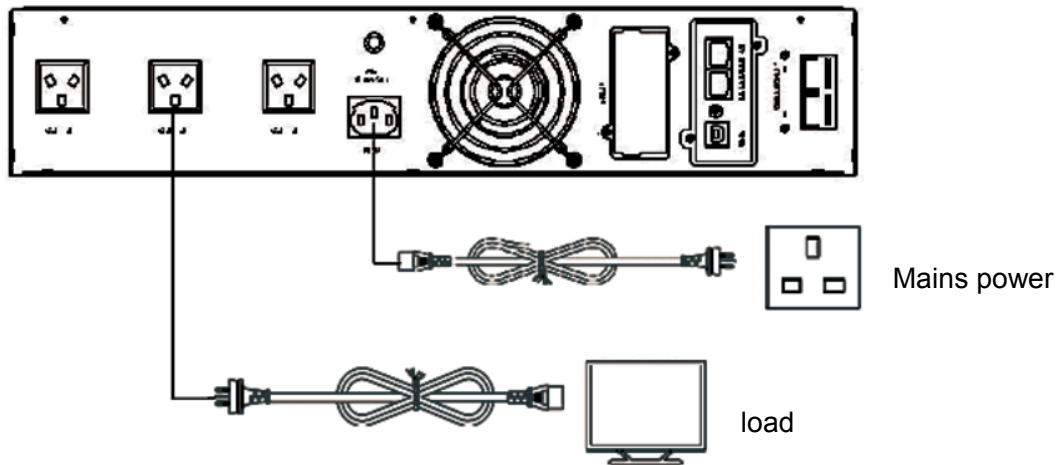

Fig. 3.2.4.1 SRT DC 24V input / output connection diagram

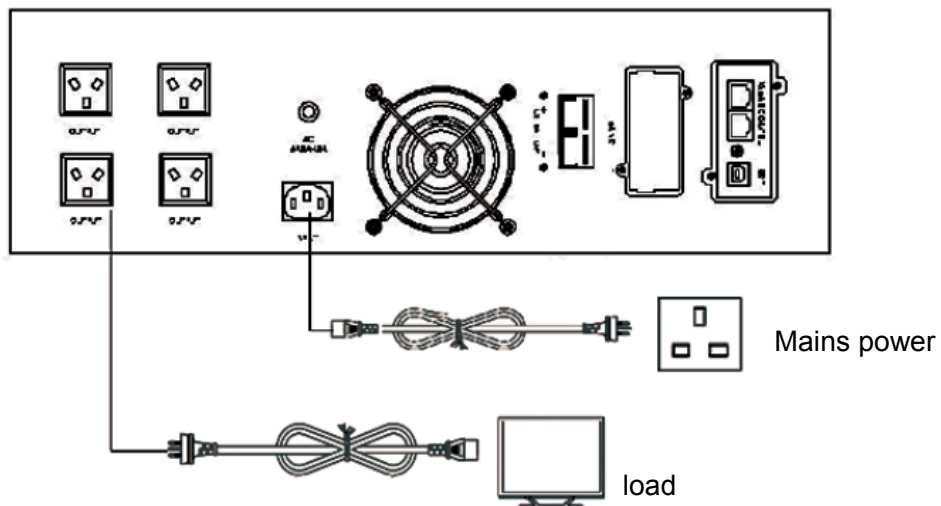

Fig. 3.2.4.1 SRT DC 48V input / output connection diagram

#### 3.2.4.2 Vertical installation

- Combine the connection extension part and RT foot to two brackets according to the following figure. Align the brackets at a proper distance and place them on a plane in parallel.

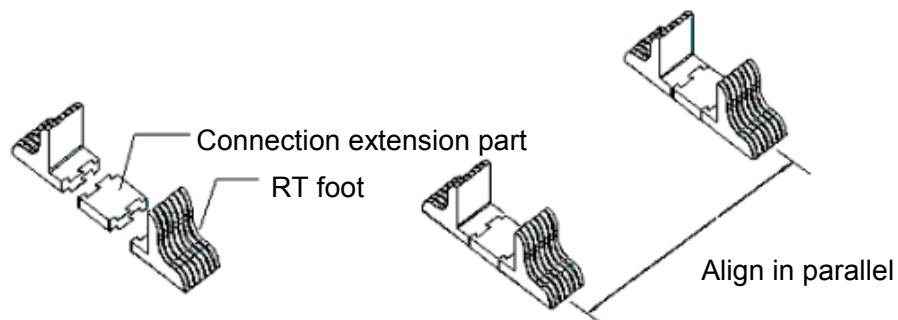

Fig. 3.2.4.2 Assembly diagram of foot pieces

- Make the UPS stand up on the two brackets. Do not turn the UPS upside down.

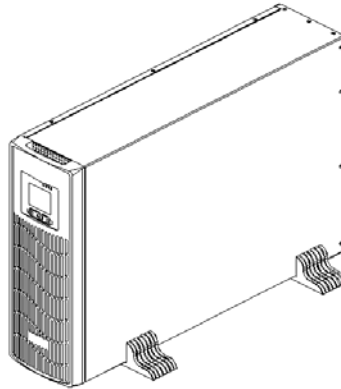

Fig. 3.2.4.2 Vertical placement

### 3.2.4.3 Rack installation

- Use screws to fasten the rack-mount brackets to the both sides of the cabinet (as shown in the following figure)

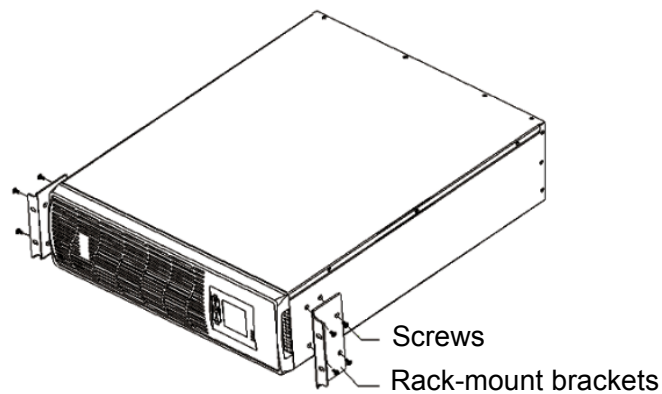

Fig. 3.2.4.3 Installation of rack-mount brackets

- Fasten the UPS on the rack after installing the rack-mount brackets (as shown in the following figure)

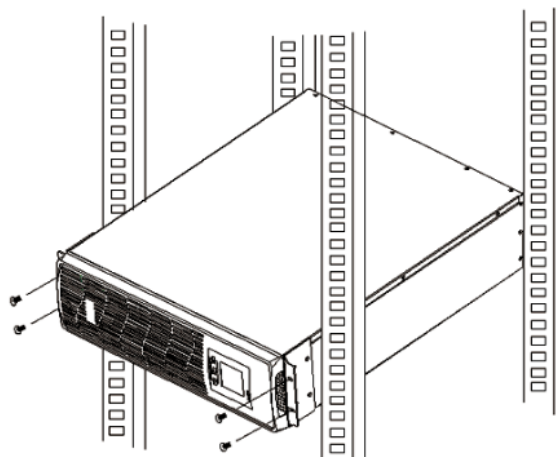

Fig. 3.2.4.3 Rack installation

## 4 Operation

### 4.1 Buttons operation



SRT Panel buttons

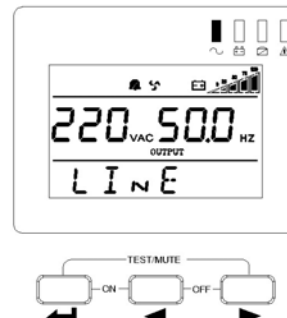

Tower panel buttons

Button	Use	Function
	<b>Power ON</b> button	Press and hold two buttons at the same time more than 3 seconds, the UPS is turned on.
	<b>Power OFF</b> button	Press and hold two buttons at the same time more than 3 seconds, the UPS is turned off.
	<b>Mute</b> button	In battery mode, press the button for 0.5 seconds, the UPS become silent (no longer giving alarm )
	<b>Test</b> button	In the condition of mains power, press two buttons at the same time for 0.5 seconds, test the battery discharging for 15 seconds.
	<b>Confirmation</b> button	<ul style="list-style-type: none"> <li>Press and hold the button for 5 seconds to enter setting interface.</li> <li>Press and hold the button for 3 seconds to exit from setting interface and not save the data.</li> <li>On setting interface, press the button for 0.5 seconds, confirm to turn the page ( display next setting)</li> <li>On setting interface, turn page to save/ exit interface, select "Yes" and press the button for 0.5 seconds, save the data and exit from the setting mode. If select "NO" and press the button for 0.5 seconds, go on confirming to turn the page ( display next setting)</li> <li>In non-setting mode, continuously press the button (0.5 seconds) twice, LCD display contents rotates.</li> </ul>
	<b>Diminishing</b> selection button	<ul style="list-style-type: none"> <li>In non-setting mode, press the button for 0.5 seconds, display page turning (page up)</li> <li>In setting mode, press the button for 0.5 seconds, parameters diminish and cycle.</li> </ul>
	<b>Increasing</b> selection button	<ul style="list-style-type: none"> <li>In non-setting mode, press the button for 0.5 seconds, display page turning (page down). Press and hold the button for 2 seconds to enter auto-flip state, press and hold the button again for 2 seconds to exit from auto-flip state.</li> <li>In setting mode, press the button for 0.5 seconds, parameters increase and cycle.</li> </ul>

## 4.2 LED Indicator light

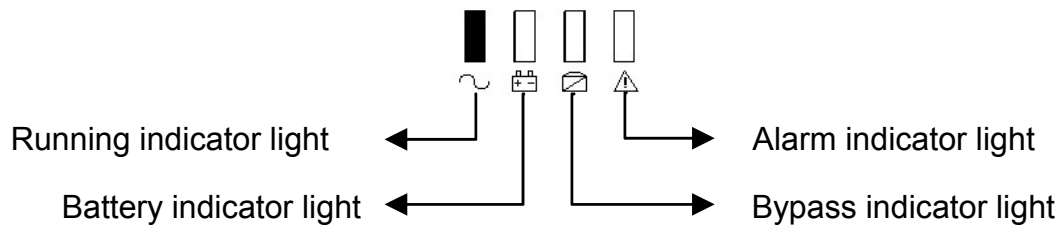

Icon	Use	Description
	Running indicator light	When the green light is illuminated, it indicates that the UPS is operating in mains mode or inverter mode.
	Battery indicator light	When the red light is illuminated, it indicates that the UPS is operating in inverter mode.
	Bypass indicator light	When the yellow light is illuminated, it indicates that the UPS is operating in bypass mode or setting mode.
	Alarm indicator light	when the red light flashes, it indicates the UPS failure (battery fault, mains fault)

## 4.3 LCD display interface

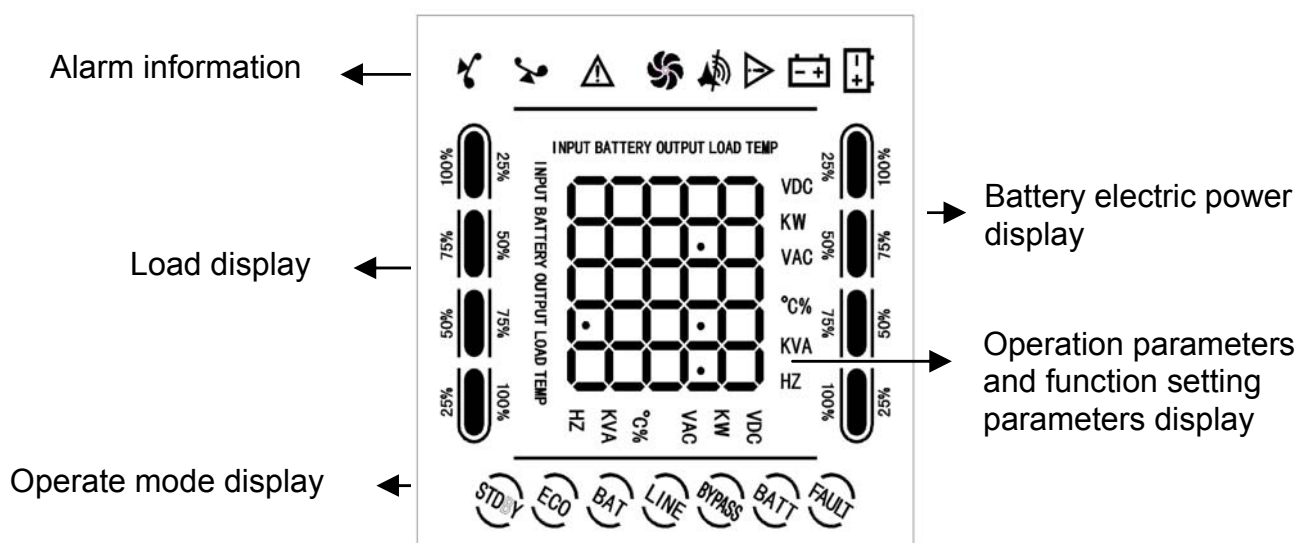



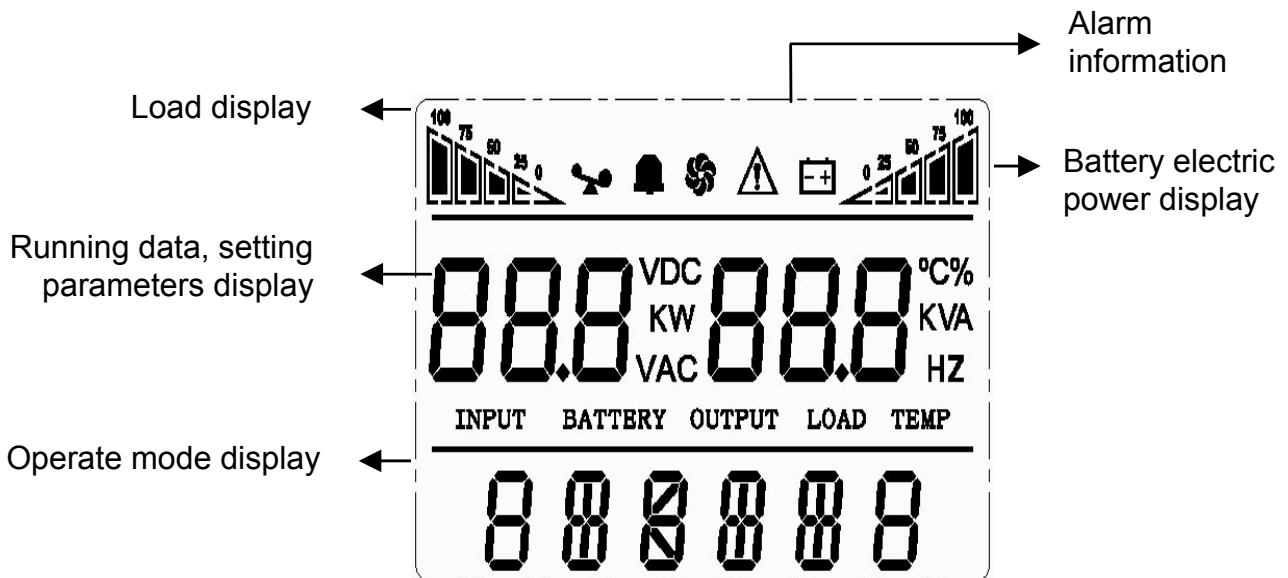

### LCD icon function description

Icon	Use	Description
	Overload indication	The load icon flashes when there is overload on UPS.
	Alarm indication	The icon flashes when the system emits an audible alarm
	Fan	Display the operating status of fans. The fan icon rotates when the fan works, the fan icon is illuminated when the fan stops working.
	Alarm display	The icon flashes when the system is abnormal, emitting an audible alarm.
	Battery indicator	The icon flashes when the battery fails.

### Display area of operation mode

The display area mainly displays the operation mode of the UPS, such as STDBY (standby mode - SRTLCD display), LINE (mains mode), BATT (battery mode), BYPASS (bypass mode - tower LCD display).

Operation Mode	Display Text	Description
Mains mode	line	In mains mode, supply stable power to the load through voltage regulator, meanwhile inverter charges the battery.
Battery mode	batt	The UPS will switch to battery mode from mains mode when the mains supply is abnormal, and continue supplying stable power to the load.
Standby mode	Pow dn	<ul style="list-style-type: none"> <li>Under normal condition of mains supply, turn off the UPS by manual, the output is in accordance with the input within the scope of bypass, not through voltage regulation circuit.</li> <li>Start up DC auto-start function in the settings, the battery is overdischarged, the inverter is shut down, the system displays standby status.</li> </ul>
Failure mode	FAULT	The system accesses to failure mode if it detects fault, meanwhile it displays fault information.

## 4.4 UPS On/Off operation

### 4.4.1 Turn on the UPS

- **Startup with utility power**

After connecting to utility power, UPS will start up and begin self-test automatically (by bypass output) and enter normal working state in 15 seconds. When UPS working indicator (green light) is illuminated and bypass indicator goes out, the user can start PC and other loads.

- **Startup with battery**

When powered by the battery (without utility power): Press Power ON button (  ) on the front panel for 3 seconds, the UPS should start up the inverter for normal power supply output, at this moment, UPS working indicator (green light) is illuminated, inverter indicator is illuminated and fault indicator flashes.

#### 4.4.2 Turn off the UPS

- **Shutdown with utility power**

Press Power OFF button ( ◀ + ▶ ) on the front panel for 3 seconds, the UPS should enter standby mode (SRT) or bypass mode (tower). The bypass indicator (yellow light) is illuminated, and cut off the utility power input, the UPS is turned off.

Shutdown with battery

Press Power OFF button ( ◀ + ▶ ) on the front panel for 3 seconds, the UPS is turned off.

#### Note:

- When turn on the UPS, firstly start up the UPS and then start up the computer and other loads; when turn off the UPS, firstly turn off the computer and other loads and then turn off the UPS.
- Once mains power fails, UPS is switched to battery power supply. Please save datas for PC and make emergency treatment for other loads in time.
- If UPS is not used for more than 7 days, please refer to steps to shutdown with utility power to turn off the UPS.
- If UPS has not been used for more than 3 months, please refer to steps to startup with utility power, charge the UPS for more than 12 hours to keep the battery fully charged and extend the battery life.

#### 4.5 Parameter query operation

- Press the query button ◀ or ▶ to check output, loads, temperature, input and battery information in turn.
- In non-setting mode, press the button ▶ for 2 seconds to enter the state of automatic page up/down, and re-press the button for 2 seconds to exit the state of automatic page up/down.
- Output: Display UPS output voltage and output frequency, as shown below (the left figure shows the display interface of SRT UPS, and the right figure shows the display interface of tower UPS):



- Load: Display WATT and VA values of the connected load, depending on load type and load capacity, as shown below (the left figure shows the display interface of SRT UPS, and the right figure shows the display interface of tower UPS):

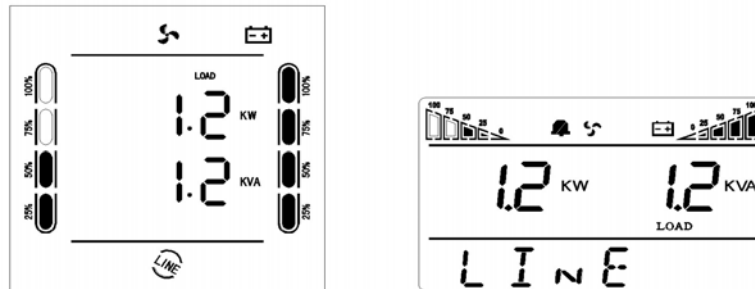

- Temperature: Display the temperature inside the cabinet, as shown below (the left figure shows the display interface of SRT UPS, and the right figure shows the display interface of tower UPS):

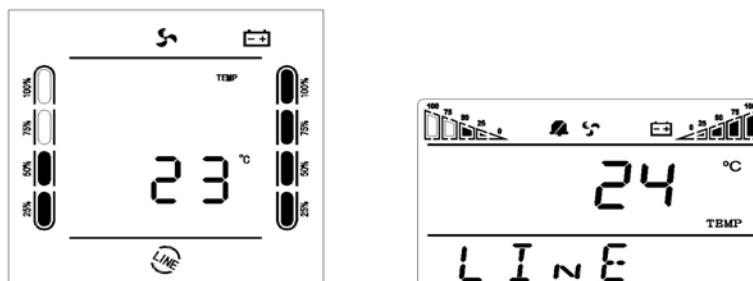

- Input: Display the input voltage and input frequency, as shown below (the left figure shows the display interface of SRT UPS, and the right figure shows the display interface of tower UPS):

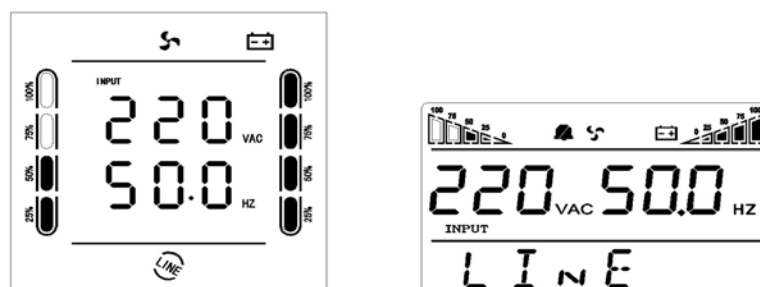



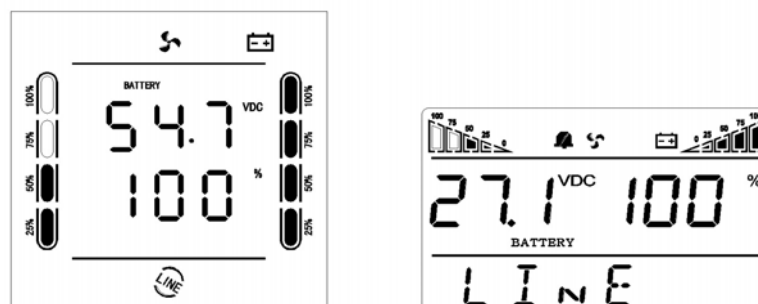











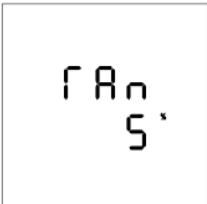

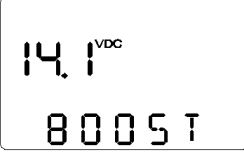

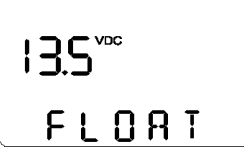

- Battery: Display the battery voltage and battery capacity, as shown below:

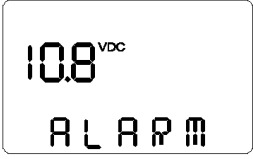

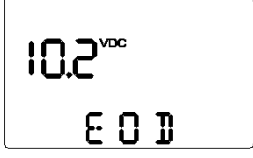

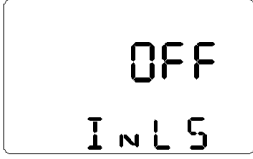

## 5 UPS Settings

Please refer to 4.1 Buttons operation for setting methods.

No.	Function Settings	LCD Display	
		SRTRT	Tower
1	OUT: Rated output voltage setting 100V / 110V / 115V / 120V, default 110 V 200V / 220V / 230V / 240V, default 220V		
2	InP / Inpove: Setting of generator input power matching (10 % ~ 150 %), default 150 %. When generator power $\leq$ rated power of the UPS, setting is required; The setting value = generator power / UPS power / 1.1 (safety factor) * 100 %		
3	FrE/FREq: Rated output frequency setting 50 HZ / 60 HZ is settable, default 60 HZ		
4	Ran/RAnG: Input frequency range setting $\pm 5\%$ ~ $\pm 15\%$ is settable, default $\pm 5\%$		
5	Boo/boost: Equalizing charge voltage setting 13.6V ~ 15.0V is settable, default 14.1V		
6	flo/FLOAT: Floating charge voltage setting 13.2V ~ 14.6V is settable, default 13.5V		

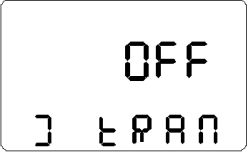
7	ALA/ALARM: Battery low voltage alarm point setting (9.6V ~ 13.0V), default 10.8V		
8	EOD: End of discharge voltage point setting (9.6V ~ 11.5V), default 10.2V		
9	CHA/CHARGE: Charging current setting Standard model: 1 ~ 3A is settable, default 1A Long backup model: 1 ~ 25A is settable, default 10A		
10	ECO/IECO: Energy-saving mode selection (ON/OFF), default OFF; If select "ON", when DC supply power and load $\leq 3\%$ , the system accesses to Sleep mode, reducing 90% of energy consumption. When increase load $> 3\%$ , the system will automatically wake up from sleep. (when start up the UPS energy-saving mode and auto-shutdown function at the same time, the system default is energy-saving mode in priority)		
11	NLS/INLS: Auto-shutdown function selection (ON/OFF), default OFF; If select "ON", verify that "NLS" (the load rate of UPS shutdown) is in the range of settings, the system will shut down after the configured time (INLS). The configured load rate shall meet actual requirements, modify if it doesn't meet. (Shall be taken as valid only when DC supply power)		

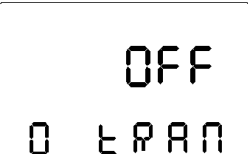
12	<p>NLS/INLS: Setting of the load rate of UPS auto-shutdown (3 % ~ 50 %), default 3 %; The load rate of shutdown needed on the scene shall prevail during application. (Shall be taken as valid only when DC supply power)</p>		
13	<p>NLS/INLS: Setting of the delay time of UPS auto-shutdown (1 ~ 99 min), default 1 min; When load ≤ setting value, the system will shut down after the configured time. (Shall be taken as valid only in battery mode)</p>		
14	<p>ACA/ACAUTO: AC auto-start function selection (ON/OFF), default “ON”; If select “OFF”, when mains power is restored after the system was overdischarged and shut down, the system will not make automatic startup.</p>		
15	<p>DCA/DCAUTO: DC auto-start function selection (ON/OFF) If select “ON”, the system is in a state of standby after the system is over discharged and shut down. When standby time ≥ DC auto-restart delay time, and the external charging capacity ≥ 50% of rated capacity of the system, the system will automatically start up (this function is used for combined solar system or system with external charging equipment)</p>		
16	<p>DCA/DCAUTO: DC auto-restart delay time setting (0.5 H ~ 8.0 H) That is the minimum time when the external charger charges the batteries after the system is over discharged and shut down. (this function is used for combined solar system or system with external charging equipment)</p>		

17	<p>ITR/I TRAN: Input voltage display setting (200 - 240V UPS: OFF / 100 / 110 / 115 / 120; 100 - 120V UPS: OFF / 200 / 220 / 230 / 240), default "OFF", displays the current rated voltage of the system; If select "100 /.../ 240", the input voltage displays "100V /.../ 240V", the transformer variable is the configured voltage value: rated voltage value.</p>		
18	<p>OTR/O TRAN: Output voltage display setting (200 - 240V UPS: OFF / 100 / 110 / 115 / 120; 100 - 120V UPS: OFF / 200 / 220 / 230 / 240), default "OFF", displays the current rated voltage of the system; If select "100 /.../ 240", the output voltage displays "100 V/.../240 V", the transformer variable is the configured voltage value: rated voltage value.</p>		
19	<p>SAVE: Save &amp; give up selection (YES / NO), default NO; If select "YES", save the modified information; if select "NO", give up modifying and go on turning the page.</p>		





## 6 Troubleshooting

### 6.1 Fault messages

No.	Fault	LCD Display	Corrective Action
1	Output short circuit	SHORT	Check if there is a short circuit on the load.
2	Output high voltage	OUT H	Inverter is abnormal, contact the supplier.
3	Output low voltage	OUT L	Inverter is abnormal, contact the supplier.
4	Output overload	LOAD	Check the load. Reduce load on system.
5	Input relay failure	RELAY	The inverter is abnormal, contact the supplier.
6	MOS fet overcurrent	MOSC	Check if there is overload or short circuit on the load. Contact the supplier if there is no abnormal situation.
7	MOS fet overtemperature	MOST	Reduce load. If the problem still exists, contact the supplier.
8	MOS fet temperature probe is disconnected	SENSOR	The inverter is abnormal, contact the supplier.
9	Transformer over temperature	TRANT	Reduce load. If the problem still exists, contact the supplier.
10	Inverter high voltage	INV H	The inverter is abnormal, contact the supplier.
11	Inverter low voltage	INV L	The inverter is abnormal, contact the supplier.
12	Inverter soft start fault	SOFT	Check if the cable connection between transformer and power board is correct. Contact the supplier if there is no abnormal situation.
13	BUS high voltage (the battery voltage is overcharged when charging the batteries)	BUS H	The inverter is abnormal, contact the supplier.
14	Charging overcurrent	CHARGE	The inverter is abnormal, contact the supplier.
15	Battery overvoltage	BATH	Check if the battery voltage is too high.
16	Low-voltage battery cut-off	EOD	Check if the batteries complete discharging or batteries are damaged. Contact the supplier if there is no abnormal situation.

## 6.2 Common faults and processing

Carry out the self checking according to the following methods in case of abnormal conditions. If the problem still exists, please contact the dealer or supplier.

Problem	Solution
<p>The utility power is normal, while UPS cannot connect to it</p>	<ul style="list-style-type: none"> <li>• Check whether the power cord is loose or not.</li> <li>• Check whether the over-current protector is out or not.</li> </ul>
<p>The utility power is normal, while UPS cannot start normally. The failure indicator is normally on, “ <ul style="list-style-type: none"> <li>• Check whether the battery wire is connected or not.</li> <li>• Confirm whether the battery is damaged or not.</li> </ul> </p>	
<p>In utility mode, the buzzer beeps continuously, “ <p>Output overload; check whether the condition of overload occurs in UPS load display or not. Reduce the load.</p> </p>	
<p>UPS can not be turned on after the “ON” button is pressed</p>	<ul style="list-style-type: none"> <li>• The “ON” button is pressed too briefly. Press the “ON” button continuously for more than 3 seconds to start UPS.</li> <li>• Check whether the battery is connected.</li> <li>• UPS has internal failure. Please contact the supplier.</li> </ul>
<p>The battery discharge time is too short</p>	<ul style="list-style-type: none"> <li>• The battery has not been fully charged. Keep UPS connected to utility power persistently for more than 8 hours to charge the battery again.</li> <li>• UPS is overloaded. Check load capacity, and reduce the load.</li> <li>• The battery is aged and the capacity decreases. Replace the battery. Please contact the supplier to obtain the battery and components for replacement.</li> </ul>

## 7 Maintenance

### 7.1 Preventive maintenance

The preventive maintenance of UPS system can ensure UPS reliability and long-term service. The following inspections can be carried out every month:

- Shut down UPS (specifically refer to operation steps);
- Check the vent hole to ensure it is not blocked;
- Check whether the cover has collected too much dust or not;
- Check whether the input, output and battery cables are firm or not and whether the cable insulation is good or not;
- Ensure UPS is well protected against moisture;
- Start UPS (specifically refer to startup operation);
- Discharge UPS powered by the battery and other unimportant loads, until the battery low voltage alarm sounds. During the period, there will be no other alarm. If any other alarm is triggered, please contact local service center.

### 7.2 Battery maintenance

This UPS adopts sealed lead-acid battery. The service life of the battery depends on the storage and service environment and battery discharge frequency. The temperature increase will shorten the service life of the battery rapidly. Even if the battery is not used, its performance will decrease gradually. It is recommended to carry out the discharge test once every three months in case of uninterrupted power supply.

The checking methods of the battery will be introduced as below (the battery performance will decrease sharply with the approaching of the expiration date, so the following checking and maintenance methods shall be kept in mind):

- Connect with the utility power cable, start UPS, and charge the battery for more than 8 hours. Pay attention to the operation condition of the loads connected to UPS.
- Maintain the load condition, and record the total power. Disconnect UPS input plug (to simulate the interruption of utility power). UPS enters battery discharge mode, until it is shut down automatically. And record the discharge time. Keep the record of initial discharge time for future use.
- The total load capacity (power consumption) shall be calculated by watts (W).
- If the nameplate only states the volt-ampere (VA) value, multiply it by the power factor (0.8, if not stated) and convert it to watts (W).
- If only the current (A) value is stated, multiply it by the rated voltage (V) and then by the power factor, and convert it to watts (W).

- The battery service life is about 1 – 2 years in normal service conditions. When the temperature is pretty high and the discharge is conducted frequently, the battery service life may be 0.5 – 1 year.
- The battery performance decreases gradually (marked by the discharge time) as the application period extends. When the discharge time decreases to 80% of initial value, its performance reduction will be accelerated. Accordingly, the battery checking time shall be changed to once per month from once half a year.
- Battery maintenance of extended runtime model (it is crucial to conduct proper maintenance for the battery to prevent the precision equipment from being damaged in case of power outage):
  - Clean the dust and dirt on the battery.
  - Check internal cable of all batteries for any looseness or corrosion. Carry out the replacement and repair if necessary.
  - Ensure the battery and battery terminals are firmly fastened.
- Tower UPS battery replacement

Turn off the UPS, remove the battery baffle from the bottom of the UPS, disconnect the battery connection wire, take out the battery (please mark connection method of the battery connection wire at this time for installation reference in the next time).

Removing method is shown below:

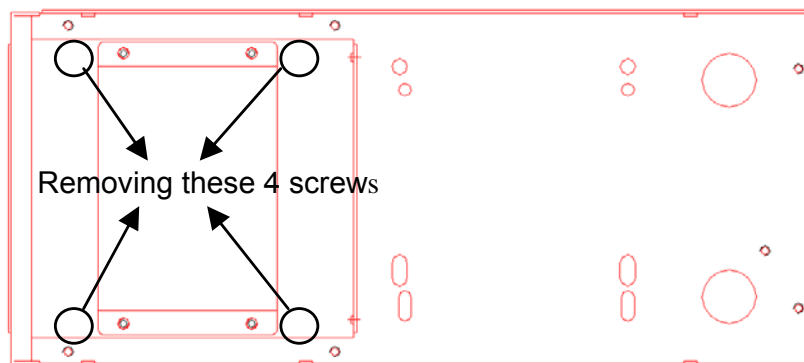

1000VA、1500VA

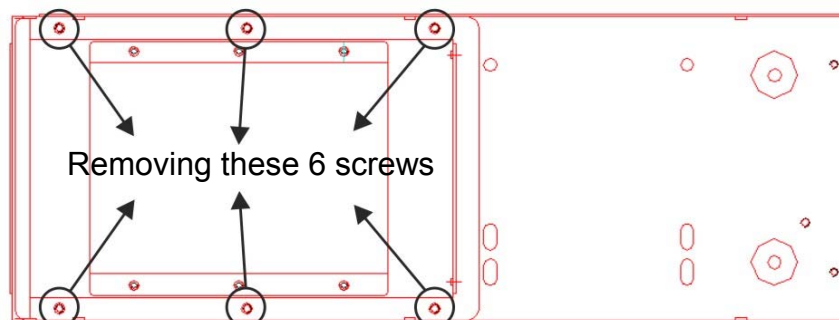

2000VA